

3D VHM BOHRER OHNE IK							PREIS
ARTIKEL NR.	D (m7)	l1	l2	l3	L	d2 (h6)	
AD103-03.00	3.0	14	20	36	62	6	
AD103-03.10	3.1	14	20	36	62	6	
AD103-03.20	3.2	14	20	36	62	6	
AD103-03.30	3.3	14	20	36	62	6	
AD103-03.40	3.4	14	20	36	62	6	
AD103-03.50	3.6	14	20	36	62	6	
AD103-03.60	3.6	14	20	36	62	6	
AD103-03.70	3.7	14	20	36	62	6	
AD103-03.80	3.8	17	24	36	66	6	
AD103-03.90	3.9	17	24	36	66	6	
AD103-04.00	4.0	17	24	36	66	6	
AD103-04.10	4.1	17	24	36	66	6	
AD103-04.20	4.2	17	24	36	66	6	
AD103-04.30	4.3	17	24	36	66	6	
AD103-04.40	4.4	17	24	36	66	6	
AD103-04.50	4.5	17	24	36	66	6	
AD103-04.60	4.6	17	24	36	66	6	
AD103-04.70	4.7	17	24	36	66	6	
AD103-04.80	4.8	20	28	36	66	6	
AD103-04.90	4.9	20	28	36	66	6	
AD103-05.00	5.0	20	28	36	66	6	
AD103-05.10	5.1	20	28	36	66	6	
AD103-05.20	5.2	20	28	36	66	6	
AD103-05.30	5.3	20	28	36	66	6	
AD103-05.40	5.4	20	28	36	66	6	
AD103-05.50	5.5	20	28	36	66	6	
AD103-05.60	5.6	20	28	36	66	6	
AD103-05.70	5.7	20	28	36	66	6	
AD103-05.80	5.8	20	28	36	66	6	
AD103-05.90	5.9	20	28	36	66	6	
AD103-06.00	6.0	20	28	36	66	6	
AD103-06.10	6.1	24	34	36	79	8	
AD103-06.20	6.2	24	34	36	79	8	
AD103-06.30	6.3	24	34	36	79	8	
AD103-06.40	6.4	24	34	36	79	8	
AD103-06.50	6.5	24	34	36	79	8	
AD103-06.60	6.6	24	34	36	79	8	
AD103-06.70	6.7	24	34	36	79	8	
AD103-06.80	6.8	24	34	36	79	8	
AD103-06.90	6.9	24	34	36	79	8	

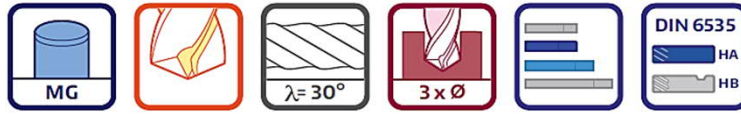

3D VHM BOHRER OHNE IK							PREIS
ARTIKEL NR.	D (m7)	l1	l2	l3	L	d2 (h6)	
AD103-07.00	7.0	24	34	36	79	8	
AD103-07.10	7.1	29	41	36	79	8	
AD103-07.20	7.2	29	41	36	79	8	
AD103-07.30	7.3	29	41	36	79	8	
AD103-07.40	7.4	29	41	36	79	8	
AD103-07.50	7.6	29	41	36	79	8	
AD103-07.60	7.6	29	41	36	79	8	
AD103-07.70	7.7	29	41	36	79	8	
AD103-07.80	7.8	29	41	36	79	8	
AD103-07.90	7.9	29	41	36	79	8	
AD103-08.00	8.0	29	41	36	79	8	
AD103-08.10	8.1	35	47	40	89	10	
AD103-08.20	8.2	35	47	40	89	10	
AD103-08.30	8.3	35	47	40	89	10	
AD103-08.40	8.4	35	47	40	89	10	
AD103-08.50	8.5	35	47	40	89	10	
AD103-08.60	8.6	35	47	40	89	10	
AD103-08.70	8.7	35	47	40	89	10	
AD103-08.80	8.8	35	47	40	89	10	
AD103-08.90	8.9	35	47	40	89	10	
AD103-09.00	9.0	35	47	40	89	10	
AD103-09.10	9.1	35	47	40	89	10	
AD103-09.20	9.2	35	47	40	89	10	
AD103-09.30	9.3	35	47	40	89	10	
AD103-09.40	9.4	35	47	40	89	10	
AD103-09.50	9.5	35	47	40	89	10	
AD103-09.60	9.6	35	47	40	89	10	
AD103-09.70	9.7	35	47	40	89	10	
AD103-09.80	9.8	35	47	40	89	10	
AD103-09.90	9.9	35	47	40	89	10	
AD103-10.00	10.0	35	47	40	89	10	
AD103-10.10	10.1	40	55	45	102	12	
AD103-10.20	10.2	40	55	45	102	12	
AD103-10.30	10.3	40	55	45	102	12	
AD103-10.40	10.4	40	55	45	102	12	
AD103-10.50	10.5	40	55	45	102	12	
AD103-10.60	10.6	40	55	45	102	12	
AD103-10.70	10.7	40	55	45	102	12	
AD103-10.80	10.8	40	55	45	102	12	
AD103-10.90	10.9	40	55	45	102	12	

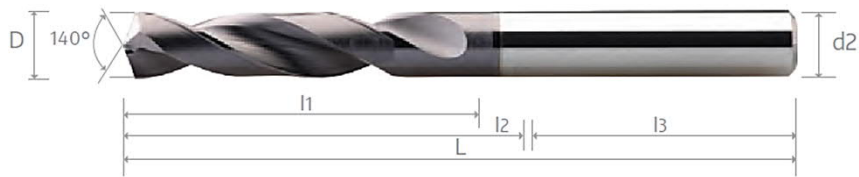
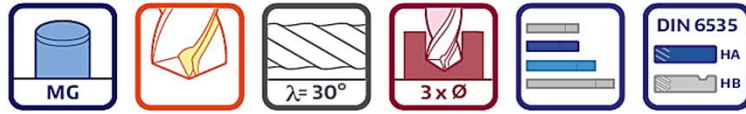
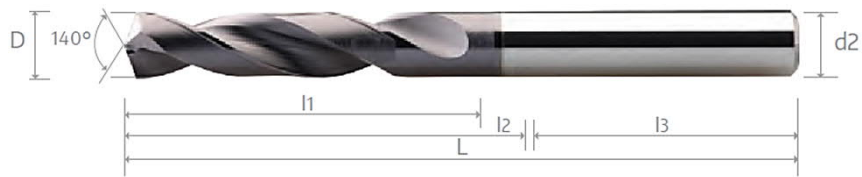

3D VHM BOHRER OHNE IK							PREIS
ARTIKEL NR.	D (m7)	l1	l2	l3	L	d2 (h6)	
AD103-11.00	11.0	40	55	45	102	12	
AD103-11.10	11.1	40	55	45	102	12	
AD103-11.20	11.2	40	55	45	102	12	
AD103-11.30	11.3	40	55	45	102	12	
AD103-11.40	11.4	40	55	45	102	12	
AD103-11.50	11.5	40	55	45	102	12	
AD103-11.60	11.6	40	55	45	102	12	
AD103-11.70	11.7	40	55	45	102	12	
AD103-11.80	11.8	40	55	45	102	12	
AD103-11.90	11.9	40	55	45	102	12	
AD103-12.00	12.0	40	55	45	102	12	
AD103-12.10	12.1	43	60	45	107	14	
AD103-12.20	12.2	43	60	45	107	14	
AD103-12.30	12.3	43	60	45	107	14	
AD103-12.40	12.4	43	60	45	107	14	
AD103-12.50	12.5	43	60	45	107	14	
AD103-12.60	12.6	43	60	45	107	14	
AD103-12.70	12.7	43	60	45	107	14	
AD103-12.80	12.8	43	60	45	107	14	
AD103-12.90	12.9	43	60	45	107	14	
AD103-13.00	13.0	43	60	45	107	14	
AD103-13.10	13.1	43	60	45	107	14	
AD103-13.20	13.2	43	60	45	107	14	
AD103-13.30	13.3	43	60	45	107	14	
AD103-13.40	13.4	43	60	45	107	14	
AD103-13.50	13.5	43	60	45	107	14	
AD103-13.60	13.6	43	60	45	107	14	
AD103-13.70	13.7	43	60	45	107	14	
AD103-13.80	13.8	43	60	45	107	14	
AD103-13.90	13.9	43	60	45	107	14	
AD103-14.00	14.0	43	60	45	107	14	
AD103-14.10	14.1	45	65	48	115	16	
AD103-14.20	14.2	45	65	48	115	16	
AD103-14.30	14.3	45	65	48	115	16	
AD103-14.40	14.4	45	65	48	115	16	
AD103-14.50	14.5	45	65	48	115	16	
AD103-14.60	14.6	45	65	48	115	16	
AD103-14.70	14.7	45	65	48	115	16	
AD103-14.80	14.8	45	65	48	115	16	
AD103-14.90	14.9	45	65	48	115	16	

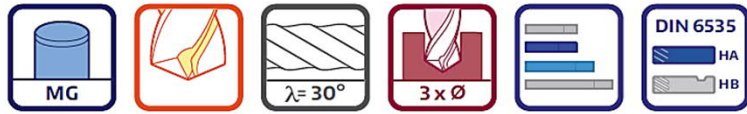
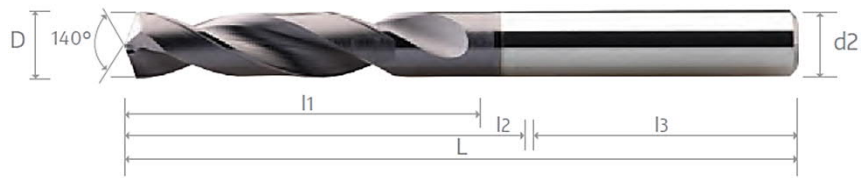

3D VHM BOHRER OHNE IK							PREIS
ARTIKEL NR.	D (m7)	l1	l2	l3	L	d2 (h6)	
AD103-15.00	15.0	45	65	48	115	16	
AD103-15.10	15.1	45	65	48	115	16	
AD103-15.20	15.2	45	65	48	115	16	
AD103-15.30	15.3	45	65	48	115	16	
AD103-15.40	15.4	45	65	48	115	16	
AD103-15.50	15.5	45	65	48	115	16	
AD103-15.60	15.6	45	65	48	115	16	
AD103-15.70	15.7	45	65	48	115	16	
AD103-15.80	15.8	45	65	48	115	16	
AD103-15.90	15.9	45	65	48	115	16	
AD103-16.00	16.0	45	65	48	115	16	
AD103-16.50	16.5	51	73	48	123	18	
AD103-17.00	17.0	51	73	48	123	18	
AD103-17.50	17.5	51	73	48	123	18	
AD103-18.00	18.0	51	73	48	123	18	
AD103-18.50	18.5	55	79	50	131	20	
AD103-19.00	19.0	55	79	50	131	20	
AD103-19.50	19.5	55	79	50	131	20	
AD103-20.00	20.0	55	79	50	131	20	

• Bis Ø32 mm möglich

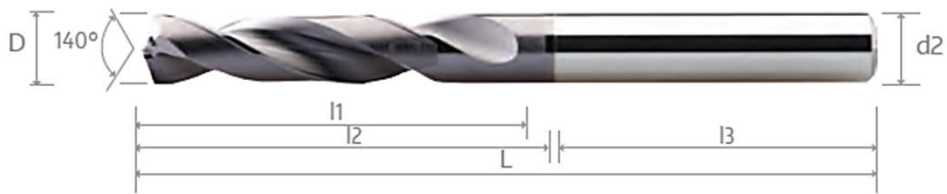

3D VHM BOHRER MIT IK							PREIS
ARTIKEL NR.	D (m7)	l1	l2	l3	L	d2 (h6)	
AD1035-03.00	3.0	14	20	36	62	6	
AD1035-03.10	3.1	14	20	36	62	6	
AD1035-03.20	3.2	14	20	36	62	6	
AD1035-03.30	3.3	14	20	36	62	6	
AD1035-03.40	3.4	14	20	36	62	6	
AD1035-03.50	3.6	14	20	36	62	6	
AD1035-03.60	3.6	14	20	36	62	6	
AD1035-03.70	3.7	14	20	36	62	6	
AD1035-03.80	3.8	17	24	36	66	6	
AD1035-03.90	3.9	17	24	36	66	6	
AD1035-04.00	4.0	17	24	36	66	6	
AD1035-04.10	4.1	17	24	36	66	6	
AD1035-04.20	4.2	17	24	36	66	6	
AD1035-04.30	4.3	17	24	36	66	6	
AD1035-04.40	4.4	17	24	36	66	6	
AD1035-04.50	4.5	17	24	36	66	6	
AD1035-04.60	4.6	17	24	36	66	6	
AD1035-04.70	4.7	17	24	36	66	6	
AD1035-04.80	4.8	20	28	36	66	6	
AD1035-04.90	4.9	20	28	36	66	6	
AD1035-05.00	5.0	20	28	36	66	6	
AD1035-05.10	5.1	20	28	36	66	6	
AD1035-05.20	5.2	20	28	36	66	6	
AD1035-05.30	5.3	20	28	36	66	6	
AD1035-05.40	5.4	20	28	36	66	6	
AD1035-05.50	5.5	20	28	36	66	6	
AD1035-05.60	5.6	20	28	36	66	6	
AD1035-05.70	5.7	20	28	36	66	6	
AD1035-05.80	5.8	20	28	36	66	6	
AD1035-05.90	5.9	20	28	36	66	6	
AD1035-06.00	6.0	20	28	36	66	6	
AD1035-06.10	6.1	24	34	36	79	8	
AD1035-06.20	6.2	24	34	36	79	8	
AD1035-06.30	6.3	24	34	36	79	8	
AD1035-06.40	6.4	24	34	36	79	8	
AD1035-06.50	6.5	24	34	36	79	8	
AD1035-06.60	6.6	24	34	36	79	8	
AD1035-06.70	6.7	24	34	36	79	8	
AD1035-06.80	6.8	24	34	36	79	8	
AD1035-06.90	6.9	24	34	36	79	8	

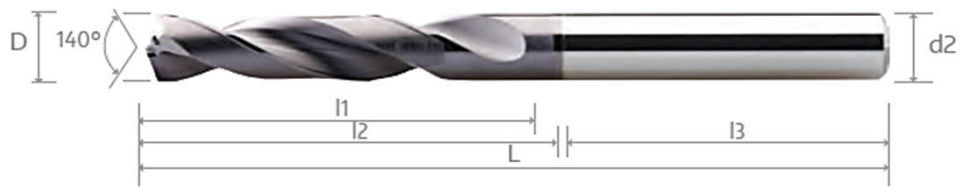

3D VHM BOHRER MIT IK							PREIS
ARTIKEL NR.	D (m7)	l1	l2	l3	L	d2 (h6)	
AD1035-07.00	7.0	24	34	36	79	8	
AD1035-07.10	7.1	29	41	36	79	8	
AD1035-07.20	7.2	29	41	36	79	8	
AD1035-07.30	7.3	29	41	36	79	8	
AD1035-07.40	7.4	29	41	36	79	8	
AD1035-07.50	7.6	29	41	36	79	8	
AD1035-07.60	7.6	29	41	36	79	8	
AD1035-07.70	7.7	29	41	36	79	8	
AD1035-07.80	7.8	29	41	36	79	8	
AD1035-07.90	7.9	29	41	36	79	8	
AD1035-08.00	8.0	29	41	36	79	8	
AD1035-08.10	8.1	35	47	40	89	10	
AD1035-08.20	8.2	35	47	40	89	10	
AD1035-08.30	8.3	35	47	40	89	10	
AD1035-08.40	8.4	35	47	40	89	10	
AD1035-08.50	8.5	35	47	40	89	10	
AD1035-08.60	8.6	35	47	40	89	10	
AD1035-08.70	8.7	35	47	40	89	10	
AD1035-08.80	8.8	35	47	40	89	10	
AD1035-08.90	8.9	35	47	40	89	10	
AD1035-09.00	9.0	35	47	40	89	10	
AD1035-09.10	9.1	35	47	40	89	10	
AD1035-09.20	9.2	35	47	40	89	10	
AD1035-09.30	9.3	35	47	40	89	10	
AD1035-09.40	9.4	35	47	40	89	10	
AD1035-09.50	9.5	35	47	40	89	10	
AD1035-09.60	9.6	35	47	40	89	10	
AD1035-09.70	9.7	35	47	40	89	10	
AD1035-09.80	9.8	35	47	40	89	10	
AD1035-09.90	9.9	35	47	40	89	10	
AD1035-10.00	10.0	35	47	40	89	10	
AD1035-10.10	10.1	40	55	45	102	12	
AD1035-10.20	10.2	40	55	45	102	12	
AD1035-10.30	10.3	40	55	45	102	12	
AD1035-10.40	10.4	40	55	45	102	12	
AD1035-10.50	10.5	40	55	45	102	12	
AD1035-10.60	10.6	40	55	45	102	12	
AD1035-10.70	10.7	40	55	45	102	12	
AD1035-10.80	10.8	40	55	45	102	12	
AD1035-10.90	10.9	40	55	45	102	12	

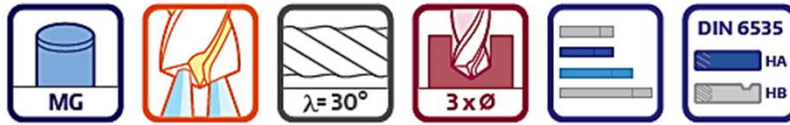
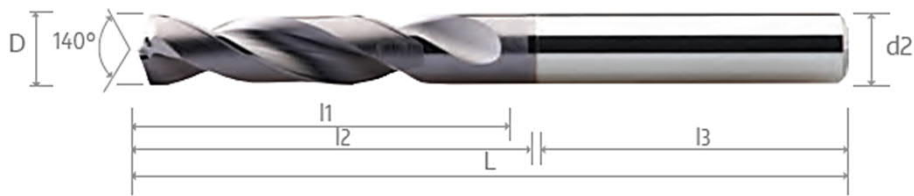

3D VHM BOHRER MIT IK							PREIS
ARTIKEL NR.	D (m7)	l1	l2	l3	L	d2 (h6)	
AD1035-11.00	11.0	40	55	45	102	12	
AD1035-11.10	11.1	40	55	45	102	12	
AD1035-11.20	11.2	40	55	45	102	12	
AD1035-11.30	11.3	40	55	45	102	12	
AD1035-11.40	11.4	40	55	45	102	12	
AD1035-11.50	11.5	40	55	45	102	12	
AD1035-11.60	11.6	40	55	45	102	12	
AD1035-11.70	11.7	40	55	45	102	12	
AD1035-11.80	11.8	40	55	45	102	12	
AD1035-11.90	11.9	40	55	45	102	12	
AD1035-12.00	12.0	40	55	45	102	12	
AD1035-12.10	12.1	43	60	45	107	14	
AD1035-12.20	12.2	43	60	45	107	14	
AD1035-12.30	12.3	43	60	45	107	14	
AD1035-12.40	12.4	43	60	45	107	14	
AD1035-12.50	12.5	43	60	45	107	14	
AD1035-12.60	12.6	43	60	45	107	14	
AD1035-12.70	12.7	43	60	45	107	14	
AD1035-12.80	12.8	43	60	45	107	14	
AD1035-12.90	12.9	43	60	45	107	14	
AD1035-13.00	13.0	43	60	45	107	14	
AD1035-13.10	13.1	43	60	45	107	14	
AD1035-13.20	13.2	43	60	45	107	14	
AD1035-13.30	13.3	43	60	45	107	14	
AD1035-13.40	13.4	43	60	45	107	14	
AD1035-13.50	13.5	43	60	45	107	14	
AD1035-13.60	13.6	43	60	45	107	14	
AD1035-13.70	13.7	43	60	45	107	14	
AD1035-13.80	13.8	43	60	45	107	14	
AD1035-13.90	13.9	43	60	45	107	14	
AD1035-14.00	14.0	43	60	45	107	14	
AD1035-14.10	14.1	45	65	48	115	16	
AD1035-14.20	14.2	45	65	48	115	16	
AD1035-14.30	14.3	45	65	48	115	16	
AD1035-14.40	14.4	45	65	48	115	16	
AD1035-14.50	14.5	45	65	48	115	16	
AD1035-14.60	14.6	45	65	48	115	16	
AD1035-14.70	14.7	45	65	48	115	16	
AD1035-14.80	14.8	45	65	48	115	16	
AD1035-14.90	14.9	45	65	48	115	16	

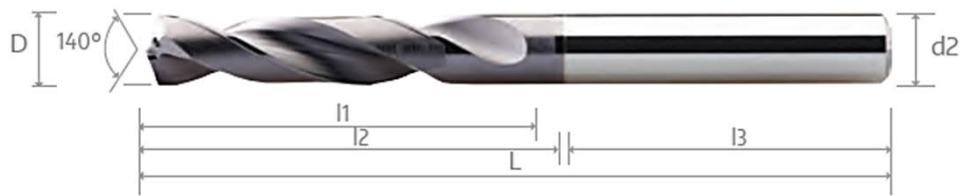

3D VHM BOHRER MIT IK							PREIS
ARTIKEL NR.	D (m7)	l1	l2	l3	L	d2 (h6)	
AD1035-15.00	15.0	45	65	48	115	16	
AD1035-15.10	15.1	45	65	48	115	16	
AD1035-15.20	15.2	45	65	48	115	16	
AD1035-15.30	15.3	45	65	48	115	16	
AD1035-15.40	15.4	45	65	48	115	16	
AD1035-15.50	15.5	45	65	48	115	16	
AD1035-15.60	15.6	45	65	48	115	16	
AD1035-15.70	15.7	45	65	48	115	16	
AD1035-15.80	15.8	45	65	48	115	16	
AD1035-15.90	15.9	45	65	48	115	16	
AD1035-16.00	16.0	45	65	48	115	16	
AD1035-16.50	16.5	51	73	48	123	18	
AD1035-17.00	17.0	51	73	48	123	18	
AD1035-17.50	17.5	51	73	48	123	18	
AD1035-18.00	18.0	51	73	48	123	18	
AD1035-18.50	18.5	55	79	50	131	20	
AD1035-19.00	19.0	55	79	50	131	20	
AD1035-19.50	19.5	55	79	50	131	20	
AD1035-20.00	20.0	55	79	50	131	20	

- Bis Ø32 mm möglich

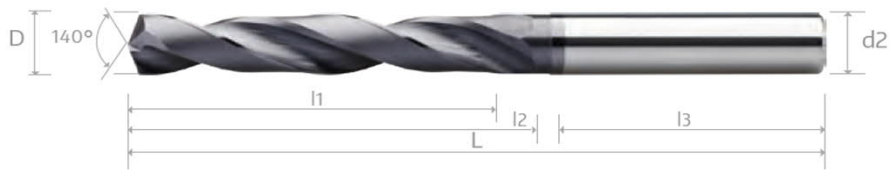

5D VHM BOHRER OHNE IK							PREIS
ARTIKEL NR.	D (m7)	l1	l2	l3	L	d2 (h6)	
AD105-03.00	3.0	23	28	36	66	6	
AD105-03.10	3.1	23	28	36	66	6	
AD105-03.20	3.2	23	28	36	66	6	
AD105-03.30	3.3	23	28	36	66	6	
AD105-03.40	3.4	23	28	36	66	6	
AD105-03.50	3.6	23	28	36	66	6	
AD105-03.60	3.6	23	28	36	66	6	
AD105-03.70	3.7	23	28	36	66	6	
AD105-03.80	3.8	29	36	36	74	6	
AD105-03.90	3.9	29	36	36	74	6	
AD105-04.00	4.0	29	36	36	74	6	
AD105-04.10	4.1	29	36	36	74	6	
AD105-04.20	4.2	29	36	36	74	6	
AD105-04.30	4.3	29	36	36	74	6	
AD105-04.40	4.4	29	36	36	74	6	
AD105-04.50	4.5	29	36	36	74	6	
AD105-04.60	4.6	29	36	36	74	6	
AD105-04.70	4.7	29	36	36	74	6	
AD105-04.80	4.8	35	44	36	82	6	
AD105-04.90	4.9	35	44	36	82	6	
AD105-05.00	5.0	35	44	36	82	6	
AD105-05.10	5.1	35	44	36	82	6	
AD105-05.20	5.2	35	44	36	82	6	
AD105-05.30	5.3	35	44	36	82	6	
AD105-05.40	5.4	35	44	36	82	6	
AD105-05.50	5.5	35	44	36	82	6	
AD105-05.60	5.6	35	44	36	82	6	
AD105-05.70	5.7	35	44	36	82	6	
AD105-05.80	5.8	35	44	36	82	6	
AD105-05.90	5.9	35	44	36	82	6	
AD105-06.00	6.0	35	44	36	82	6	
AD105-06.10	6.1	43	53	36	91	8	
AD105-06.20	6.2	43	53	36	91	8	
AD105-06.30	6.3	43	53	36	91	8	
AD105-06.40	6.4	43	53	36	91	8	
AD105-06.50	6.5	43	53	36	91	8	
AD105-06.60	6.6	43	53	36	91	8	
AD105-06.70	6.7	43	53	36	91	8	
AD105-06.80	6.8	43	53	36	91	8	
AD105-06.90	6.9	43	53	36	91	8	

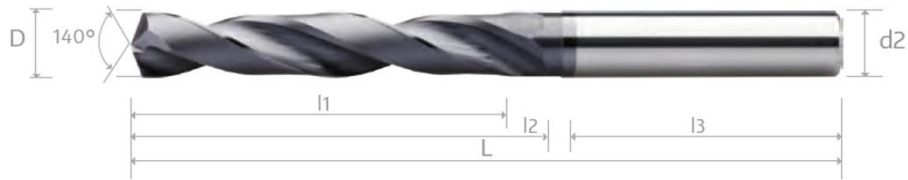

5D VHM BOHRER OHNE IK							PREIS
ARTIKEL NR.	D (m7)	l1	l2	l3	L	d2 (h6)	
AD105-07.00	7.0	43	53	36	91	8	
AD105-07.10	7.1	43	53	36	91	8	
AD105-07.20	7.2	43	53	36	91	8	
AD105-07.30	7.3	43	53	36	91	8	
AD105-07.40	7.4	43	53	36	91	8	
AD105-07.50	7.6	43	53	36	91	8	
AD105-07.60	7.6	43	53	36	91	8	
AD105-07.70	7.7	43	53	36	91	8	
AD105-07.80	7.8	43	53	36	91	8	
AD105-07.90	7.9	43	53	36	91	8	
AD105-08.00	8.0	43	53	36	91	8	
AD105-08.10	8.1	49	61	40	103	10	
AD105-08.20	8.2	49	61	40	103	10	
AD105-08.30	8.3	49	61	40	103	10	
AD105-08.40	8.4	49	61	40	103	10	
AD105-08.50	8.5	49	61	40	103	10	
AD105-08.60	8.6	49	61	40	103	10	
AD105-08.70	8.7	49	61	40	103	10	
AD105-08.80	8.8	49	61	40	103	10	
AD105-08.90	8.9	49	61	40	103	10	
AD105-09.00	9.0	49	61	40	103	10	
AD105-09.10	9.1	49	61	40	103	10	
AD105-09.20	9.2	49	61	40	103	10	
AD105-09.30	9.3	49	61	40	103	10	
AD105-09.40	9.4	49	61	40	103	10	
AD105-09.50	9.5	49	61	40	103	10	
AD105-09.60	9.6	49	61	40	103	10	
AD105-09.70	9.7	49	61	40	103	10	
AD105-09.80	9.8	49	61	40	103	10	
AD105-09.90	9.9	49	61	40	103	10	
AD105-10.00	10.0	49	61	40	103	10	
AD105-10.10	10.1	56	71	45	118	12	
AD105-10.20	10.2	56	71	45	118	12	
AD105-10.30	10.3	56	71	45	118	12	
AD105-10.40	10.4	56	71	45	118	12	
AD105-10.50	10.5	56	71	45	118	12	
AD105-10.60	10.6	56	71	45	118	12	
AD105-10.70	10.7	56	71	45	118	12	
AD105-10.80	10.8	56	71	45	118	12	
AD105-10.90	10.9	56	71	45	118	12	

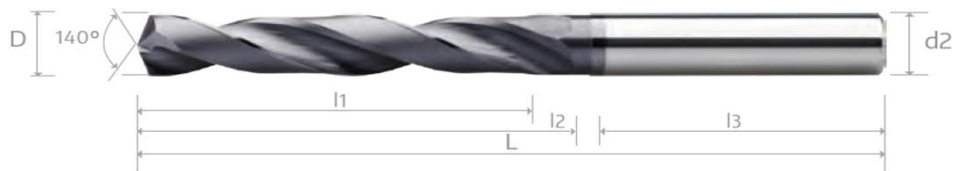

5D VHM BOHRER OHNE IK							PREIS
ARTIKEL NR.	D (m7)	l1	l2	l3	L	d2 (h6)	
AD105-11.00	11.0	56	71	45	118	12	
AD105-11.10	11.1	56	71	45	118	12	
AD105-11.20	11.2	56	71	45	118	12	
AD105-11.30	11.3	56	71	45	118	12	
AD105-11.40	11.4	56	71	45	118	12	
AD105-11.50	11.5	56	71	45	118	12	
AD105-11.60	11.6	56	71	45	118	12	
AD105-11.70	11.7	56	71	45	118	12	
AD105-11.80	11.8	56	71	45	118	12	
AD105-11.90	11.9	56	71	45	118	12	
AD105-12.00	12.0	56	71	45	118	12	
AD105-12.10	12.1	60	77	45	124	14	
AD105-12.20	12.2	60	77	45	124	14	
AD105-12.30	12.3	60	77	45	124	14	
AD105-12.40	12.4	60	77	45	124	14	
AD105-12.50	12.5	60	77	45	124	14	
AD105-12.60	12.6	60	77	45	124	14	
AD105-12.70	12.7	60	77	45	124	14	
AD105-12.80	12.8	60	77	45	124	14	
AD105-12.90	12.9	60	77	45	124	14	
AD105-13.00	13.0	60	77	45	124	14	
AD105-13.10	13.1	60	77	45	124	14	
AD105-13.20	13.2	60	77	45	124	14	
AD105-13.30	13.3	60	77	45	124	14	
AD105-13.40	13.4	60	77	45	124	14	
AD105-13.50	13.5	60	77	45	124	14	
AD105-13.60	13.6	60	77	45	124	14	
AD105-13.70	13.7	60	77	45	124	14	
AD105-13.80	13.8	60	77	45	124	14	
AD105-13.90	13.9	60	77	45	124	14	
AD105-14.00	14.0	60	77	45	124	14	
AD105-14.10	14.1	63	88	48	133	16	
AD105-14.20	14.2	63	88	48	133	16	
AD105-14.30	14.3	63	88	48	133	16	
AD105-14.40	14.4	63	88	48	133	16	
AD105-14.50	14.5	63	88	48	133	16	
AD105-14.60	14.6	63	88	48	133	16	
AD105-14.70	14.7	63	88	48	133	16	
AD105-14.80	14.8	63	88	48	133	16	
AD105-14.90	14.9	63	88	48	133	16	

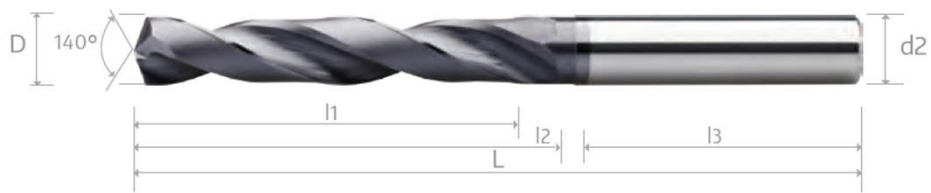

5D VHM BOHRER OHNE IK							PREIS
ARTIKEL NR.	D (m7)	l1	l2	l3	L	d2 (h6)	
AD105-15.00	15.0	63	88	48	133	16	
AD105-15.10	15.1	63	88	48	133	16	
AD105-15.20	15.2	63	88	48	133	16	
AD105-15.30	15.3	63	88	48	133	16	
AD105-15.40	15.4	63	88	48	133	16	
AD105-15.50	15.5	63	88	48	133	16	
AD105-15.60	15.6	63	88	48	133	16	
AD105-15.70	15.7	63	88	48	133	16	
AD105-15.80	15.8	63	88	48	133	16	
AD105-15.90	15.9	63	88	48	133	16	
AD105-16.00	16.0	63	88	48	133	16	
AD105-16.50	16.5	71	93	48	143	18	
AD105-17.00	17.0	71	93	48	143	18	
AD105-17.50	17.5	71	93	48	143	18	
AD105-18.00	18.0	71	93	48	143	18	
AD105-18.50	18.5	77	101	50	153	20	
AD105-19.00	19.0	77	101	50	153	20	
AD105-19.50	19.5	77	101	50	153	20	
AD105-20.00	20.0	77	101	50	153	20	

• Bis Ø32 mm möglich

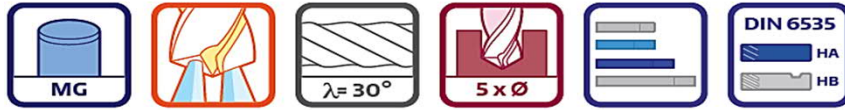
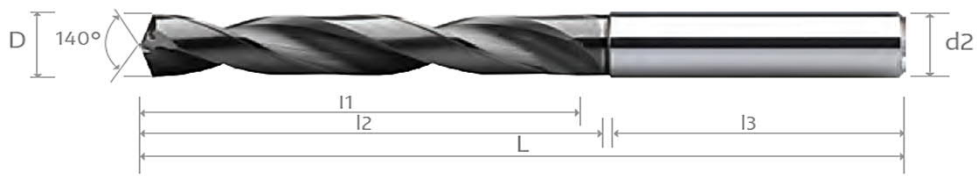

5D VHM BOHRER MIT IK							PREIS
ARTIKEL NR.	D (m7)	l1	l2	l3	L	d2 (h6)	
AD1055-03.00	3.0	23	28	36	66	6	
AD1055-03.10	3.1	23	28	36	66	6	
AD1055-03.20	3.2	23	28	36	66	6	
AD1055-03.30	3.3	23	28	36	66	6	
AD1055-03.40	3.4	23	28	36	66	6	
AD1055-03.50	3.6	23	28	36	66	6	
AD1055-03.60	3.6	23	28	36	66	6	
AD1055-03.70	3.7	23	28	36	66	6	
AD1055-03.80	3.8	29	36	36	74	6	
AD1055-03.90	3.9	29	36	36	74	6	
AD1055-04.00	4.0	29	36	36	74	6	
AD1055-04.10	4.1	29	36	36	74	6	
AD1055-04.20	4.2	29	36	36	74	6	
AD1055-04.30	4.3	29	36	36	74	6	
AD1055-04.40	4.4	29	36	36	74	6	
AD1055-04.50	4.5	29	36	36	74	6	
AD1055-04.60	4.6	29	36	36	74	6	
AD1055-04.70	4.7	29	36	36	74	6	
AD1055-04.80	4.8	35	44	36	82	6	
AD1055-04.90	4.9	35	44	36	82	6	
AD1055-05.00	5.0	35	44	36	82	6	
AD1055-05.10	5.1	35	44	36	82	6	
AD1055-05.20	5.2	35	44	36	82	6	
AD1055-05.30	5.3	35	44	36	82	6	
AD1055-05.40	5.4	35	44	36	82	6	
AD1055-05.50	5.5	35	44	36	82	6	
AD1055-05.60	5.6	35	44	36	82	6	
AD1055-05.70	5.7	35	44	36	82	6	
AD1055-05.80	5.8	35	44	36	82	6	
AD1055-05.90	5.9	35	44	36	82	6	
AD1055-06.00	6.0	35	44	36	82	6	
AD1055-06.10	6.1	43	53	36	91	8	
AD1055-06.20	6.2	43	53	36	91	8	
AD1055-06.30	6.3	43	53	36	91	8	
AD1055-06.40	6.4	43	53	36	91	8	
AD1055-06.50	6.5	43	53	36	91	8	
AD1055-06.60	6.6	43	53	36	91	8	
AD1055-06.70	6.7	43	53	36	91	8	
AD1055-06.80	6.8	43	53	36	91	8	
AD1055-06.90	6.9	43	53	36	91	8	

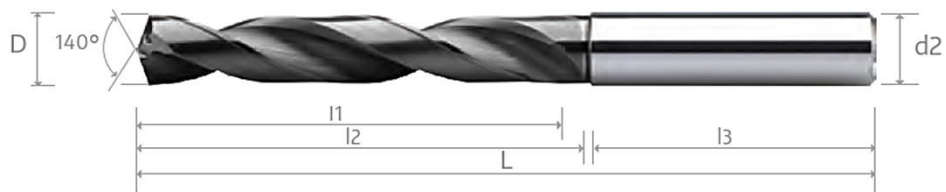

5D VHM BOHRER MIT IK							PREIS
ARTIKEL NR.	D (m7)	l1	l2	l3	L	d2 (h6)	
AD1055-07.00	7.0	43	53	36	91	8	
AD1055-07.10	7.1	43	53	36	91	8	
AD1055-07.20	7.2	43	53	36	91	8	
AD1055-07.30	7.3	43	53	36	91	8	
AD1055-07.40	7.4	43	53	36	91	8	
AD1055-07.50	7.6	43	53	36	91	8	
AD1055-07.60	7.6	43	53	36	91	8	
AD1055-07.70	7.7	43	53	36	91	8	
AD1055-07.80	7.8	43	53	36	91	8	
AD1055-07.90	7.9	43	53	36	91	8	
AD1055-08.00	8.0	43	53	36	91	8	
AD1055-08.10	8.1	49	61	40	103	10	
AD1055-08.20	8.2	49	61	40	103	10	
AD1055-08.30	8.3	49	61	40	103	10	
AD1055-08.40	8.4	49	61	40	103	10	
AD1055-08.50	8.5	49	61	40	103	10	
AD1055-08.60	8.6	49	61	40	103	10	
AD1055-08.70	8.7	49	61	40	103	10	
AD1055-08.80	8.8	49	61	40	103	10	
AD1055-08.90	8.9	49	61	40	103	10	
AD1055-09.00	9.0	49	61	40	103	10	
AD1055-09.10	9.1	49	61	40	103	10	
AD1055-09.20	9.2	49	61	40	103	10	
AD1055-09.30	9.3	49	61	40	103	10	
AD1055-09.40	9.4	49	61	40	103	10	
AD1055-09.50	9.5	49	61	40	103	10	
AD1055-09.60	9.6	49	61	40	103	10	
AD1055-09.70	9.7	49	61	40	103	10	
AD1055-09.80	9.8	49	61	40	103	10	
AD1055-09.90	9.9	49	61	40	103	10	
AD1055-10.00	10.0	49	61	40	103	10	
AD1055-10.10	10.1	56	71	45	118	12	
AD1055-10.20	10.2	56	71	45	118	12	
AD1055-10.30	10.3	56	71	45	118	12	
AD1055-10.40	10.4	56	71	45	118	12	
AD1055-10.50	10.5	56	71	45	118	12	
AD1055-10.60	10.6	56	71	45	118	12	
AD1055-10.70	10.7	56	71	45	118	12	
AD1055-10.80	10.8	56	71	45	118	12	
AD1055-10.90	10.9	56	71	45	118	12	

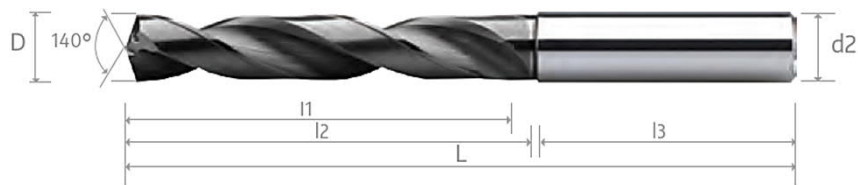

5D VHM BOHRER MIT IK							PREIS
ARTIKEL NR.	D (m7)	l1	l2	l3	L	d2 (h6)	
AD1055-11.00	11.0	56	71	45	118	12	
AD1055-11.10	11.1	56	71	45	118	12	
AD1055-11.20	11.2	56	71	45	118	12	
AD1055-11.30	11.3	56	71	45	118	12	
AD1055-11.40	11.4	56	71	45	118	12	
AD1055-11.50	11.5	56	71	45	118	12	
AD1055-11.60	11.6	56	71	45	118	12	
AD1055-11.70	11.7	56	71	45	118	12	
AD1055-11.80	11.8	56	71	45	118	12	
AD1055-11.90	11.9	56	71	45	118	12	
AD1055-12.00	12.0	56	71	45	118	12	
AD1055-12.10	12.1	60	77	45	124	14	
AD1055-12.20	12.2	60	77	45	124	14	
AD1055-12.30	12.3	60	77	45	124	14	
AD1055-12.40	12.4	60	77	45	124	14	
AD1055-12.50	12.5	60	77	45	124	14	
AD1055-12.60	12.6	60	77	45	124	14	
AD1055-12.70	12.7	60	77	45	124	14	
AD1055-12.80	12.8	60	77	45	124	14	
AD1055-12.90	12.9	60	77	45	124	14	
AD1055-13.00	13.0	60	77	45	124	14	
AD1055-13.10	13.1	60	77	45	124	14	
AD1055-13.20	13.2	60	77	45	124	14	
AD1055-13.30	13.3	60	77	45	124	14	
AD1055-13.40	13.4	60	77	45	124	14	
AD1055-13.50	13.5	60	77	45	124	14	
AD1055-13.60	13.6	60	77	45	124	14	
AD1055-13.70	13.7	60	77	45	124	14	
AD1055-13.80	13.8	60	77	45	124	14	
AD1055-13.90	13.9	60	77	45	124	14	
AD1055-14.00	14.0	60	77	45	124	14	
AD1055-14.10	14.1	63	88	48	133	16	
AD1055-14.20	14.2	63	88	48	133	16	
AD1055-14.30	14.3	63	88	48	133	16	
AD1055-14.40	14.4	63	88	48	133	16	
AD1055-14.50	14.5	63	88	48	133	16	
AD1055-14.60	14.6	63	88	48	133	16	
AD1055-14.70	14.7	63	88	48	133	16	
AD1055-14.80	14.8	63	88	48	133	16	
AD1055-14.90	14.9	63	88	48	133	16	

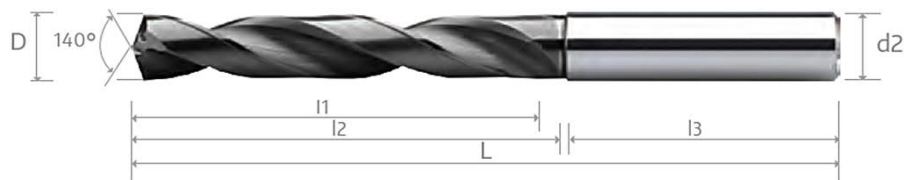

5D VHM BOHRER MIT IK							PREIS
ARTIKEL NR.	D (m7)	l1	l2	l3	L	d2 (h6)	
AD1055-15.00	15.0	63	88	48	133	16	
AD1055-15.10	15.1	63	88	48	133	16	
AD1055-15.20	15.2	63	88	48	133	16	
AD1055-15.30	15.3	63	88	48	133	16	
AD1055-15.40	15.4	63	88	48	133	16	
AD1055-15.50	15.5	63	88	48	133	16	
AD1055-15.60	15.6	63	88	48	133	16	
AD1055-15.70	15.7	63	88	48	133	16	
AD1055-15.80	15.8	63	88	48	133	16	
AD1055-15.90	15.9	63	88	48	133	16	
AD1055-16.00	16.0	63	88	48	133	16	
AD1055-16.50	16.5	71	93	48	143	18	
AD1055-17.00	17.0	71	93	48	143	18	
AD1055-17.50	17.5	71	93	48	143	18	
AD1055-18.00	18.0	71	93	48	143	18	
AD1055-18.50	18.5	77	101	50	153	20	
AD1055-19.00	19.0	77	101	50	153	20	
AD1055-19.50	19.5	77	101	50	153	20	
AD1055-20.00	20.0	77	101	50	153	20	

• Bis Ø32 mm möglich

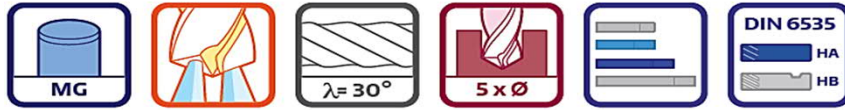
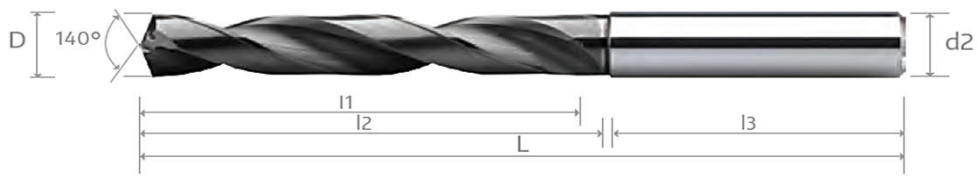

7D VHM BOHRER MIT IK							PREIS
ARTIKEL NR.	D (m7)	l1	l2	l3	L	d2 (h6)	
AD1075-03.00	3.0	30	34	36	70	6	
AD1075-03.10	3.1	30	34	36	70	6	
AD1075-03.20	3.2	30	34	36	70	6	
AD1075-03.30	3.3	30	34	36	70	6	
AD1075-03.40	3.4	35,5	39	36	75	6	
AD1075-03.50	3.6	35,5	39	36	75	6	
AD1075-03.60	3.6	35,5	39	36	75	6	
AD1075-03.70	3.7	35,5	39	36	75	6	
AD1075-03.80	3.8	37,5	39	36	75	6	
AD1075-03.90	3.9	37,5	39	36	75	6	
AD1075-04.00	4.0	37,5	39	36	75	6	
AD1075-04.10	4.1	37,5	39	36	75	6	
AD1075-04.20	4.2	37,5	39	36	75	6	
AD1075-04.30	4.3	45	49	36	85	6	
AD1075-04.40	4.4	45	49	36	85	6	
AD1075-04.50	4.5	45	49	36	85	6	
AD1075-04.60	4.6	45	49	36	85	6	
AD1075-04.70	4.7	45	49	36	85	6	
AD1075-04.80	4.8	50	54	36	90	6	
AD1075-04.90	4.9	50	54	36	90	6	
AD1075-05.00	5.0	50	54	36	90	6	
AD1075-05.10	5.1	50	54	36	90	6	
AD1075-05.20	5.2	50	54	36	90	6	
AD1075-05.30	5.3	50	54	36	90	6	
AD1075-05.40	5.4	57	61	36	97	6	
AD1075-05.50	5.5	57	61	36	97	6	
AD1075-05.60	5.6	57	61	36	97	6	
AD1075-05.70	5.7	57	61	36	97	6	
AD1075-05.80	5.8	57	61	36	97	6	
AD1075-05.90	5.9	57	61	36	97	6	
AD1075-06.00	6.0	57	61	36	97	6	
AD1075-06.10	6.1	66	70	36	106	8	
AD1075-06.20	6.2	66	70	36	106	8	
AD1075-06.30	6.3	66	70	36	106	8	
AD1075-06.40	6.4	66	70	36	106	8	
AD1075-06.50	6.5	66	70	36	106	8	
AD1075-06.60	6.6	66	70	36	106	8	
AD1075-06.70	6.7	66	70	36	106	8	
AD1075-06.80	6.8	66	70	36	106	8	
AD1075-06.90	6.9	76	80	36	116	8	

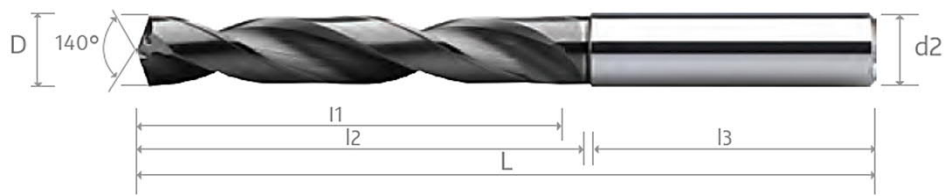

7D VHM BOHRER MIT IK							PREIS
ARTIKEL NR.	D (m7)	l1	l2	l3	L	d2 (h6)	
AD1075-07.00	7.0	76	80	36	116	8	
AD1075-07.10	7.1	76	80	36	116	8	
AD1075-07.20	7.2	76	80	36	116	8	
AD1075-07.30	7.3	76	80	36	116	8	
AD1075-07.40	7.4	76	80	36	116	8	
AD1075-07.50	7.6	76	80	36	116	8	
AD1075-07.60	7.6	76	80	36	116	8	
AD1075-07.70	7.7	76	80	36	116	8	
AD1075-07.80	7.8	76	80	36	116	8	
AD1075-07.90	7.9	76	80	36	116	8	
AD1075-08.00	8.0	76	80	36	116	8	
AD1075-08.10	8.1	87	91	40	131	10	
AD1075-08.20	8.2	87	91	40	131	10	
AD1075-08.30	8.3	87	91	40	131	10	
AD1075-08.40	8.4	87	91	40	131	10	
AD1075-08.50	8.5	87	91	40	131	10	
AD1075-08.60	8.6	87	91	40	131	10	
AD1075-08.70	8.7	87	91	40	131	10	
AD1075-08.80	8.8	87	91	40	131	10	
AD1075-08.90	8.9	87	91	40	131	10	
AD1075-09.00	9.0	87	91	40	131	10	
AD1075-09.10	9.1	95	99	40	139	10	
AD1075-09.20	9.2	95	99	40	139	10	
AD1075-09.30	9.3	95	99	40	139	10	
AD1075-09.40	9.4	95	99	40	139	10	
AD1075-09.50	9.5	95	99	40	139	10	
AD1075-09.60	9.6	95	99	40	139	10	
AD1075-09.70	9.7	95	99	40	139	10	
AD1075-09.80	9.8	95	99	40	139	10	
AD1075-09.90	9.9	95	99	40	139	10	
AD1075-10.00	10.0	95	99	40	139	10	
AD1075-10.10	10.1	106	110	45	155	12	
AD1075-10.20	10.2	106	110	45	155	12	
AD1075-10.30	10.3	106	110	45	155	12	
AD1075-10.40	10.4	106	110	45	155	12	
AD1075-10.50	10.5	106	110	45	155	12	
AD1075-10.60	10.6	106	110	45	155	12	
AD1075-10.70	10.7	106	110	45	155	12	
AD1075-10.80	10.8	106	110	45	155	12	
AD1075-10.90	10.9	106	110	45	155	12	

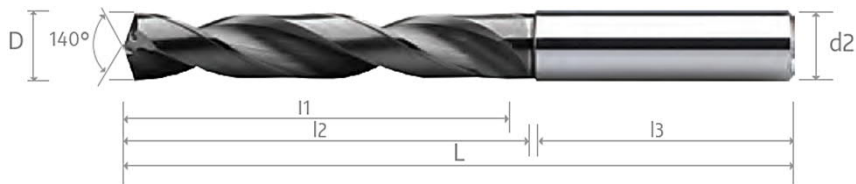

7D VHM BOHRER MIT IK							PREIS
ARTIKEL NR.	D (m7)	l1	l2	l3	L	d2 (h6)	
AD1075-11.00	11.0	106	110	45	155	12	
AD1075-11.10	11.1	114	118	45	163	12	
AD1075-11.20	11.2	114	118	45	163	12	
AD1075-11.30	11.3	114	118	45	163	12	
AD1075-11.40	11.4	114	118	45	163	12	
AD1075-11.50	11.5	114	118	45	163	12	
AD1075-11.60	11.6	114	118	45	163	12	
AD1075-11.70	11.7	114	118	45	163	12	
AD1075-11.80	11.8	114	118	45	163	12	
AD1075-11.90	11.9	114	118	45	163	12	
AD1075-12.00	12.0	114	118	45	163	12	
AD1075-12.10	12.1	133	137	45	182	14	
AD1075-12.20	12.2	133	137	45	182	14	
AD1075-12.30	12.3	133	137	45	182	14	
AD1075-12.40	12.4	133	137	45	182	14	
AD1075-12.50	12.5	133	137	45	182	14	
AD1075-12.60	12.6	133	137	45	182	14	
AD1075-12.70	12.7	133	137	45	182	14	
AD1075-12.80	12.8	133	137	45	182	14	
AD1075-12.90	12.9	133	137	45	182	14	
AD1075-13.00	13.0	133	137	45	182	14	
AD1075-13.10	13.1	133	137	45	182	14	
AD1075-13.20	13.2	133	137	45	182	14	
AD1075-13.30	13.3	133	137	45	182	14	
AD1075-13.40	13.4	133	137	45	182	14	
AD1075-13.50	13.5	133	137	45	182	14	
AD1075-13.60	13.6	133	137	45	182	14	
AD1075-13.70	13.7	133	137	45	182	14	
AD1075-13.80	13.8	133	137	45	182	14	
AD1075-13.90	13.9	133	137	45	182	14	
AD1075-14.00	14.0	133	137	45	182	14	
AD1075-14.10	14.1	152	156	48	204	16	
AD1075-14.20	14.2	152	156	48	204	16	
AD1075-14.30	14.3	152	156	48	204	16	
AD1075-14.40	14.4	152	156	48	204	16	
AD1075-14.50	14.5	152	156	48	204	16	
AD1075-14.60	14.6	152	156	48	204	16	
AD1075-14.70	14.7	152	156	48	204	16	
AD1075-14.80	14.8	152	156	48	204	16	
AD1075-14.90	14.9	152	156	48	204	16	

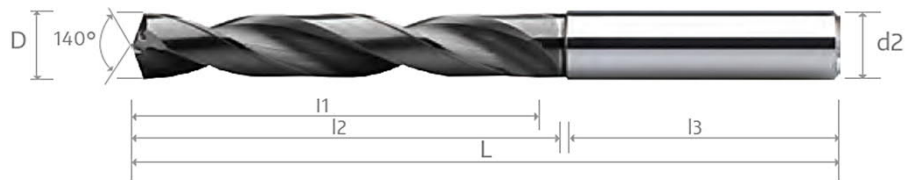

7D VHM BOHRER MIT IK							PREIS
ARTIKEL NR.	D (m7)	l1	l2	l3	L	d2 (h6)	
AD1075-15.00	15.0	152	156	48	204	16	
AD1075-15.10	15.1	152	156	48	204	16	
AD1075-15.20	15.2	152	156	48	204	16	
AD1075-15.30	15.3	152	156	48	204	16	
AD1075-15.40	15.4	152	156	48	204	16	
AD1075-15.50	15.5	152	156	48	204	16	
AD1075-15.60	15.6	152	156	48	204	16	
AD1075-15.70	15.7	152	156	48	204	16	
AD1075-15.80	15.8	152	156	48	204	16	
AD1075-15.90	15.9	152	156	48	204	16	
AD1075-16.00	16.0	152	156	48	204	16	
AD1075-16.50	16.5	171	175	48	223	18	
AD1075-17.00	17.0	171	175	48	223	18	
AD1075-17.50	17.5	171	175	48	223	18	
AD1075-18.00	18.0	171	175	48	223	18	
AD1075-18.50	18.5	190	194	50	244	20	
AD1075-19.00	19.0	190	194	50	244	20	
AD1075-19.50	19.5	190	194	50	244	20	
AD1075-20.00	20.0	190	194	50	244	20	

• Bis Ø32 mm möglich

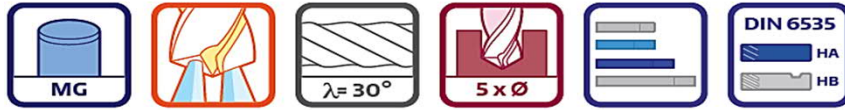
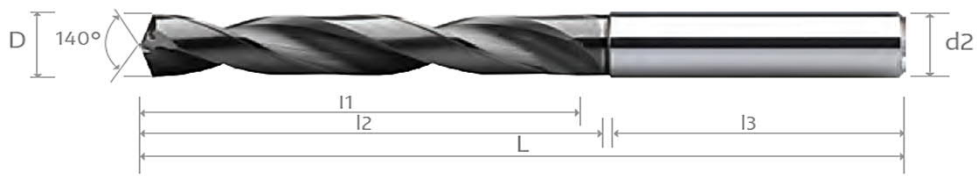

12D VHM BOHRER MIT IK							PREIS
ARTIKEL NR.	D (m7)	l1	l2	l3	L	d2 (h6)	
AD1125-03.00	3.0	50	54	36	90	6	
AD1125-03.10	3.1	50	54	36	90	6	
AD1125-03.20	3.2	50	54	36	90	6	
AD1125-03.30	3.3	50	54	36	90	6	
AD1125-03.40	3.4	50	54	36	90	6	
AD1125-03.50	3.6	50	54	36	90	6	
AD1125-03.60	3.6	50	54	36	90	6	
AD1125-03.70	3.7	50	54	36	90	6	
AD1125-03.80	3.8	64	66	36	102	6	
AD1125-03.90	3.9	64	66	36	102	6	
AD1125-04.00	4.0	64	66	36	102	6	
AD1125-04.10	4.1	64	66	36	102	6	
AD1125-04.20	4.2	64	66	36	102	6	
AD1125-04.30	4.3	64	66	36	102	6	
AD1125-04.40	4.4	64	66	36	102	6	
AD1125-04.50	4.5	64	66	36	102	6	
AD1125-04.60	4.6	64	66	36	102	6	
AD1125-04.70	4.7	64	66	36	102	6	
AD1125-04.80	4.8	78	80	36	116	6	
AD1125-04.90	4.9	78	80	36	116	6	
AD1125-05.00	5.0	78	80	36	116	6	
AD1125-05.10	5.1	78	80	36	116	6	
AD1125-05.20	5.2	78	80	36	116	6	
AD1125-05.30	5.3	78	80	36	116	6	
AD1125-05.40	5.4	78	80	36	116	6	
AD1125-05.50	5.5	78	80	36	116	6	
AD1125-05.60	5.6	78	80	36	116	6	
AD1125-05.70	5.7	78	80	36	116	6	
AD1125-05.80	5.8	78	80	36	116	6	
AD1125-05.90	5.9	78	80	36	116	6	
AD1125-06.00	6.0	78	80	36	116	6	
AD1125-06.10	6.1	108	110	36	146	8	
AD1125-06.20	6.2	108	110	36	146	8	
AD1125-06.30	6.3	108	110	36	146	8	
AD1125-06.40	6.4	108	110	36	146	8	
AD1125-06.50	6.5	108	110	36	146	8	
AD1125-06.60	6.6	108	110	36	146	8	
AD1125-06.70	6.7	108	110	36	146	8	
AD1125-06.80	6.8	108	110	36	146	8	
AD1125-06.90	6.9	108	110	36	146	8	

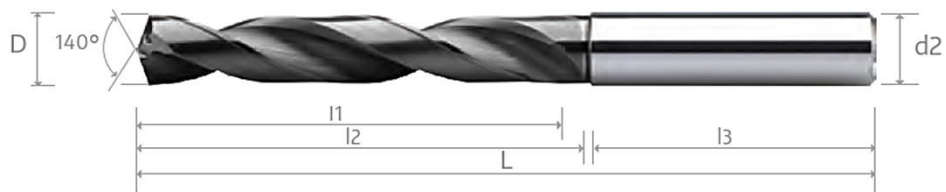

12D VHM BOHRER MIT IK							PREIS
ARTIKEL NR.	D (m7)	l1	l2	l3	L	d2 (h6)	
AD1125-07.00	7.0	108	110	36	146	8	
AD1125-07.10	7.1	108	110	36	146	8	
AD1125-07.20	7.2	108	110	36	146	8	
AD1125-07.30	7.3	108	110	36	146	8	
AD1125-07.40	7.4	108	110	36	146	8	
AD1125-07.50	7.6	108	110	36	146	8	
AD1125-07.60	7.6	108	110	36	146	8	
AD1125-07.70	7.7	108	110	36	146	8	
AD1125-07.80	7.8	108	110	36	146	8	
AD1125-07.90	7.9	108	110	36	146	8	
AD1125-08.00	8.0	108	110	36	146	8	
AD1125-08.10	8.1	120	122	40	162	10	
AD1125-08.20	8.2	120	122	40	162	10	
AD1125-08.30	8.3	120	122	40	162	10	
AD1125-08.40	8.4	120	122	40	162	10	
AD1125-08.50	8.5	120	122	40	162	10	
AD1125-08.60	8.6	120	122	40	162	10	
AD1125-08.70	8.7	120	122	40	162	10	
AD1125-08.80	8.8	120	122	40	162	10	
AD1125-08.90	8.9	120	122	40	162	10	
AD1125-09.00	9.0	120	122	40	162	10	
AD1125-09.10	9.1	120	122	40	162	10	
AD1125-09.20	9.2	120	122	40	162	10	
AD1125-09.30	9.3	120	122	40	162	10	
AD1125-09.40	9.4	120	122	40	162	10	
AD1125-09.50	9.5	120	122	40	162	10	
AD1125-09.60	9.6	120	122	40	162	10	
AD1125-09.70	9.7	120	122	40	162	10	
AD1125-09.80	9.8	120	122	40	162	10	
AD1125-09.90	9.9	120	122	40	162	10	
AD1125-10.00	10.0	120	122	40	162	10	
AD1125-10.10	10.1	156	159	45	204	12	
AD1125-10.20	10.2	156	159	45	204	12	
AD1125-10.30	10.3	156	159	45	204	12	
AD1125-10.40	10.4	156	159	45	204	12	
AD1125-10.50	10.5	156	159	45	204	12	
AD1125-10.60	10.6	156	159	45	204	12	
AD1125-10.70	10.7	156	159	45	204	12	
AD1125-10.80	10.8	156	159	45	204	12	
AD1125-10.90	10.9	156	159	45	204	12	

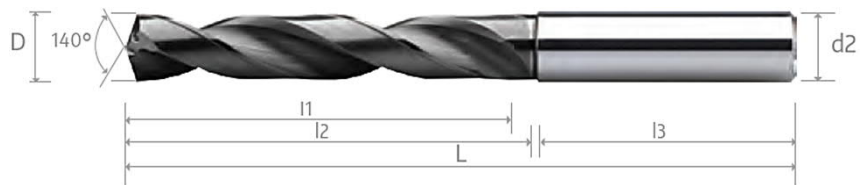

12D VHM BOHRER MIT IK							PREIS
ARTIKEL NR.	D (m7)	l1	l2	l3	L	d2 (h6)	
AD1125-11.00	11.0	156	159	45	204	12	
AD1125-11.10	11.1	156	159	45	204	12	
AD1125-11.20	11.2	156	159	45	204	12	
AD1125-11.30	11.3	156	159	45	204	12	
AD1125-11.40	11.4	156	159	45	204	12	
AD1125-11.50	11.5	156	159	45	204	12	
AD1125-11.60	11.6	156	159	45	204	12	
AD1125-11.70	11.7	156	159	45	204	12	
AD1125-11.80	11.8	156	159	45	204	12	
AD1125-11.90	11.9	156	159	45	204	12	
AD1125-12.00	12.0	156	159	45	204	12	
AD1125-12.50	12.5	182	185	45	230	14	
AD1125-13.00	13.0	182	185	45	230	14	
AD1125-13.50	13.5	182	185	45	230	14	
AD1125-14.00	14.0	182	185	45	230	14	
AD1125-14.50	14.5	208	212	48	260	16	
AD1125-15.00	15.0	208	212	48	260	16	
AD1125-15.50	15.5	208	212	48	260	16	
AD1125-16.00	16.0	208	212	48	260	16	
AD1125-16.50	16.5	234	237	48	285	18	
AD1125-17.00	17.0	234	237	48	285	18	
AD1125-17.50	17.5	234	237	48	285	18	
AD1125-18.00	18.0	234	237	48	285	18	
AD1125-18.50	18.5	258	260	50	310	20	
AD1125-19.00	19.0	258	260	50	310	20	
AD1125-19.50	19.5	258	260	50	310	20	
AD1125-20.00	20.0	258	260	50	310	20	

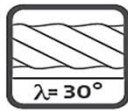
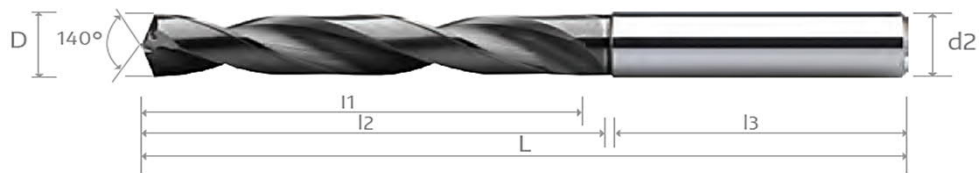

15D VHM BOHRER MIT IK							PREIS
ARTIKEL NR.	D (m7)	l1	l2	l3	L	d2 (h6)	
AD1155-03.00	3.0	55	58	36	94	6	
AD1155-03.10	3.1	66	70	36	106	6	
AD1155-03.20	3.2	66	70	36	106	6	
AD1155-03.30	3.3	66	70	36	106	6	
AD1155-03.40	3.4	76	80	36	116	6	
AD1155-03.50	3.6	76	80	36	116	6	
AD1155-03.60	3.6	76	80	36	116	6	
AD1155-03.70	3.7	76	80	36	116	6	
AD1155-03.80	3.8	76	80	36	116	6	
AD1155-03.90	3.9	76	80	36	116	6	
AD1155-04.00	4.0	76	80	36	116	6	
AD1155-04.10	4.1	93	97	36	133	6	
AD1155-04.20	4.2	93	97	36	133	6	
AD1155-04.30	4.3	93	97	36	133	6	
AD1155-04.40	4.4	93	97	36	133	6	
AD1155-04.50	4.5	93	97	36	133	6	
AD1155-04.60	4.6	93	97	36	133	6	
AD1155-04.70	4.7	93	97	36	133	6	
AD1155-04.80	4.8	93	97	36	133	6	
AD1155-04.90	4.9	93	97	36	133	6	
AD1155-05.00	5.0	93	97	36	133	6	
AD1155-05.20	5.2	110	114	36	150	6	
AD1155-05.40	5.4	110	114	36	150	6	
AD1155-05.60	5.6	110	114	36	150	6	
AD1155-05.80	5.8	110	114	36	150	6	
AD1155-06.00	6.0	110	114	36	150	6	
AD1155-06.20	6.2	127	131	36	167	8	
AD1155-06.40	6.4	127	131	36	167	8	
AD1155-06.60	6.6	127	131	36	167	8	
AD1155-06.80	6.8	127	131	36	167	8	
AD1155-07.00	7.0	127	131	36	167	8	
AD1155-07.20	7.2	143	147	36	183	8	
AD1155-07.40	7.4	143	147	36	183	8	
AD1155-07.50	7.6	143	147	36	183	8	
AD1155-07.80	7.8	143	147	36	183	8	
AD1155-08.00	8.0	143	147	36	183	8	
AD1155-08.50	8.5	160	164	40	204	10	
AD1155-09.00	9.0	160	164	40	204	10	
AD1155-10.00	10.0	177	181	40	221	10	
AD1155-10.50	10.5	198	202	45	247	12	
AD1155-11.00	11.0	198	202	45	247	12	

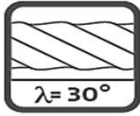
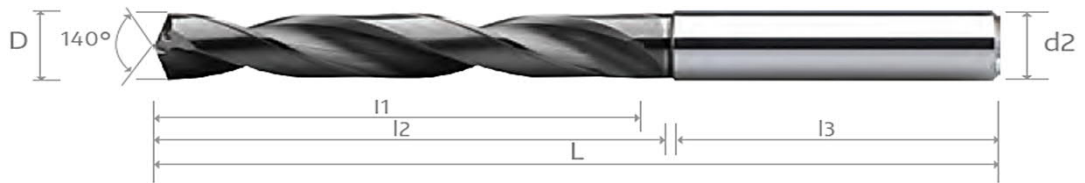

15D VHM BOHRER MIT IK							PREIS
ARTIKEL NR.	D (m7)	l1	l2	l3	L	d2 (h6)	
AD1155-11.50	11.5	214	218	45	263	12	
AD1155-12.00	12.0	214	218	45	263	12	
AD1155-12.50	12.5	248	252	45	297	14	
AD1155-13.00	13.0	248	252	45	297	14	
AD1155-13.50	13.5	248	252	45	297	14	
AD1155-14.00	14.0	248	252	45	297	14	
AD1155-14.50	14.50	281	284	45	333	16	
AD1155-15.00	15.00	281	284	45	333	16	
AD1155-15.50	15.50	281	284	45	333	16	
AD1155-16.00	16.00	281	284	45	333	16	

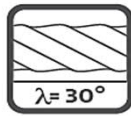
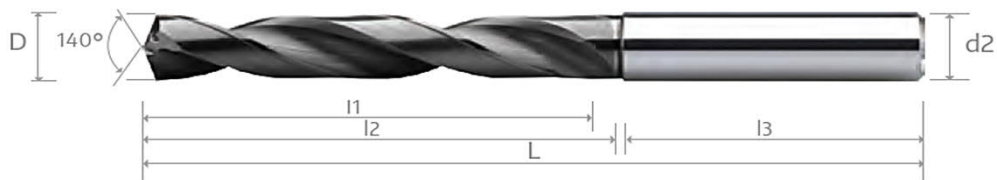

20D VHM BOHRER MIT IK							PREIS
ARTIKEL NR.	D (m7)	l1	l2	l3	L	d2 (h6)	
AD1205-03.00	3.0	70	74	36	110	6	
AD1205-03.10	3.1	83	87	36	123	6	
AD1205-03.20	3.2	83	87	36	123	6	
AD1205-03.30	3.3	83	87	36	123	6	
AD1205-03.40	3.4	96	100	36	136	6	
AD1205-03.50	3.6	96	100	36	136	6	
AD1205-03.60	3.6	96	100	36	136	6	
AD1205-03.70	3.7	96	100	36	136	6	
AD1205-03.80	3.8	96	100	36	136	6	
AD1205-03.90	3.9	96	100	36	136	6	
AD1205-04.00	4.0	96	100	36	136	6	
AD1205-04.10	4.1	118	122	36	158	6	
AD1205-04.20	4.2	118	122	36	158	6	
AD1205-04.30	4.3	118	122	36	158	6	
AD1205-04.40	4.4	118	122	36	158	6	
AD1205-04.50	4.5	118	122	36	158	6	
AD1205-04.60	4.6	118	122	36	158	6	
AD1205-04.70	4.7	118	122	36	158	6	
AD1205-04.80	4.8	118	122	36	158	6	
AD1205-04.90	4.9	118	122	36	158	6	
AD1205-05.00	5.0	118	122	36	158	6	
AD1205-05.20	5.2	140	144	36	180	6	
AD1205-05.40	5.4	140	144	36	180	6	
AD1205-05.60	5.6	140	144	36	180	6	
AD1205-05.80	5.8	140	144	36	180	6	
AD1205-06.00	6.0	140	144	36	180	6	
AD1205-06.20	6.2	162	166	36	202	8	
AD1205-06.40	6.4	162	166	36	202	8	
AD1205-06.60	6.6	162	166	36	202	8	
AD1205-06.80	6.8	162	166	36	202	8	
AD1205-07.00	7.0	162	166	36	202	8	
AD1205-07.20	7.2	183	187	36	223	8	
AD1205-07.40	7.4	183	187	36	223	8	
AD1205-07.50	7.6	183	187	36	223	8	
AD1205-07.80	7.8	183	187	36	223	8	
AD1205-08.00	8.0	183	187	36	223	8	
AD1205-08.50	8.5	205	209	40	249	10	
AD1205-09.00	9.0	205	209	40	249	10	
AD1205-10.00	10.0	227	231	40	271	10	
AD1205-10.50	10.5	253	257	45	302	12	
AD1205-11.00	11.0	253	257	45	302	12	

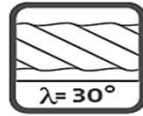
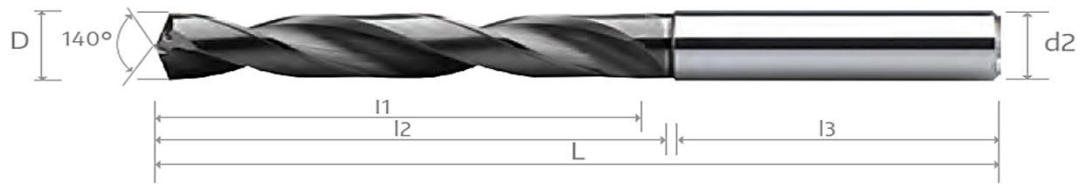

20D VHM BOHRER MIT IK							PREIS
ARTIKEL NR.	D (m7)	l1	l2	l3	L	d2 (h6)	
AD1205-11.50	11.5	274	278	45	323	12	
AD1205-12.00	12.0	274	278	45	323	12	

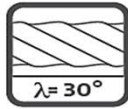
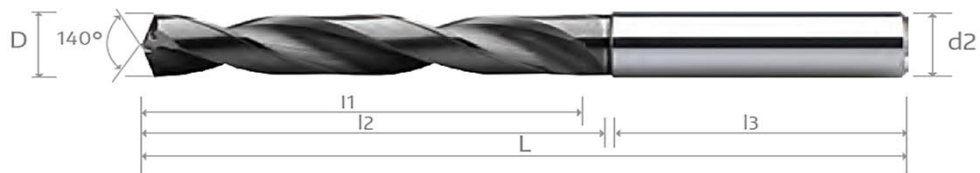

30D VHM BOHRER MIT IK							PREIS
ARTIKEL NR.	D (m7)	l1	l2	l3	L	d2 (h6)	
AD1305-05.00	5.0	168	172	36	208	6	
AD1305-05.20	5.2	200	204	36	240	6	
AD1305-05.40	5.4	200	204	36	240	6	
AD1305-05.60	5.6	200	204	36	240	6	
AD1305-05.80	5.8	200	204	36	240	6	
AD1305-06.00	6.0	200	204	36	240	6	
AD1305-06.20	6.2	232	236	36	272	8	
AD1305-06.40	6.4	232	236	36	272	8	
AD1305-06.60	6.6	232	236	36	272	8	
AD1305-06.80	6.8	232	236	36	272	8	
AD1305-07.00	7.0	232	236	36	272	8	
AD1305-07.20	7.2	263	267	36	303	8	
AD1305-07.40	7.4	263	267	36	303	8	
AD1305-07.50	7.6	263	267	36	303	8	
AD1305-07.80	7.8	263	267	36	303	8	
AD1305-08.00	8.0	263	267	36	303	8	

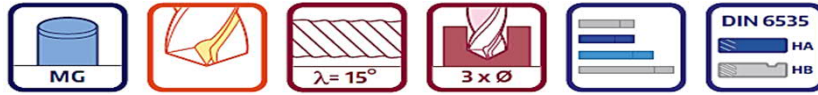
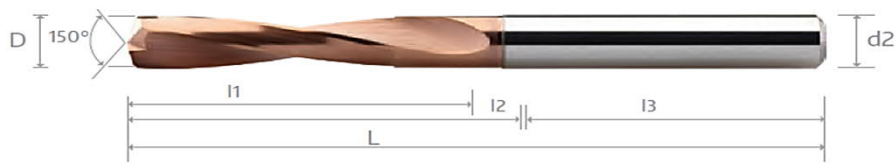

3D VHM BOHRER OHNE IK 65 HRC							PREIS
ARTIKEL NR.	D (m7)	l1	l2	l3	L	d2 (h6)	
AD1038-03.00/03.5	3.0 - 3.5	14	20	36	65	6	
AD1038-03.60/04.5	3.6 - 4.5	17	24	36	65	6	
AD1038-04.60/06.0	4.6 - 6	20	28	36	65	6	
AD1038-06.10/08.0	6.1 - 8	29	41	36	82	8	
AD1038-08.10/10.0	8.1 - 10	35	47	40	89	10	
AD1038-10.10/12.0	10.1 - 12	40	55	45	102	12	
AD1038-12.10/14.0	12.1 - 14	43	60	45	107	14	
AD1038-14.10/16.0	14.1 - 16	45	65	50	120	16	
AD1038-16.10/18.0	16.1 - 18	51	73	50	130	18	
AD1038-18.10/20.0	18.1 - 20	55	78	50	130	20	

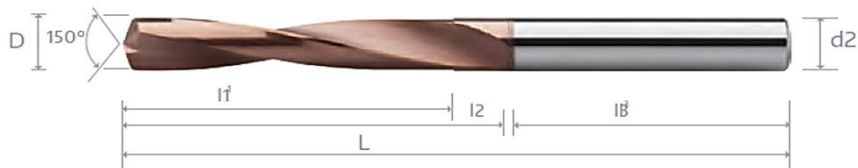

5D VHM BOHRER OHNE IK 65 HRC							PREIS
ARTIKEL NR.	D (m7)	l1	l2	l3	L	d2 (h6)	
AD1058-03.00/03.5	3.0 - 3.5	23	28	36	65	6	
AD1058-03.60/04.5	3.6 - 4.5	29	36	36	74	6	
AD1058-04.60/06.0	4.6 - 6	35	44	36	82	6	
AD1058-06.10/08.0	6.1 - 8	43	53	36	91	8	
AD1058-08.10/10.0	8.1 - 10	49	61	40	103	10	
AD1058-10.10/12.0	10.1 - 12	56	71	45	118	12	
AD1058-12.10/14.0	12.1 - 14	60	76	45	123	14	
AD1058-14.10/16.0	14.1 - 16	63	83	48	133	16	
AD1058-16.10/18.0	16.1 - 18	71	93	48	143	18	
AD1058-18.10/20.0	18.1 - 20	77	101	50	153	20	

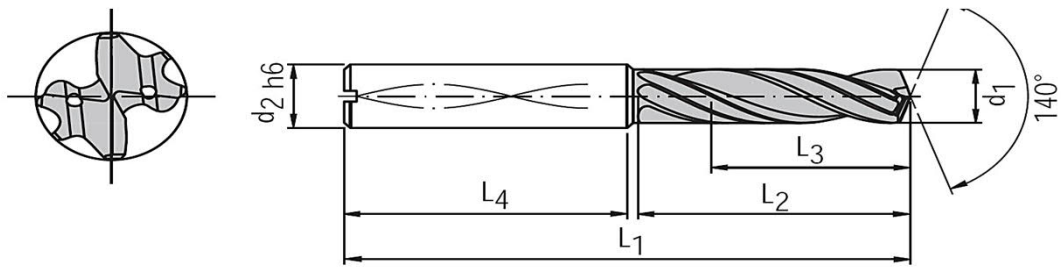

VHM BOHRREIBAHLE							PREIS
ARTIKEL NR.	d1	d2 (h6)	L1	L2	L3	Z	
AD2205-05.98	5.98	8	82	44	36	2	
AD2205-05.99	5.99	8	82	44	36	2	
AD2205-06.00	6	8	82	44	36	2	
AD2205-06.01	6.01	8	82	44	36	2	
AD2205-06.02	6.02	8	82	44	36	2	
AD2205-07.98	7.98	10	91	53	36	2	
AD2205-07.99	7.99	10	91	53	36	2	
AD2205-08.00	8	10	91	53	36	2	
AD2205-08.01	8.01	10	91	53	40	2	
AD2205-08.02	8.02	10	91	53	40	2	
AD2205-09.98	9.98	12	103	61	40	2	
AD2205-09.99	9.99	12	103	61	40	2	
AD2205-10.00	10	12	103	61	40	2	
AD2205-10.01	10.01	12	103	61	45	2	
AD2205-10.02	10.02	12	103	61	45	2	
AD2205-11.98	11.98	14	118	71	45	2	
AD2205-11.99	11.99	14	118	71	45	2	
AD2205-12.00	12	14	118	71	45	2	
AD2205-12.01	12.01	14	118	71	45	2	
AD2205-12.02	12.02	14	118	71	45	2	
AD2205-14.00	14	16	124	77	45	2	
AD2205-16.00	16	18	133	83	48	2	
AD2205-18.00	18	20	143	93	48	2	
AD2205-20.00	20	20	153	101	50	2	

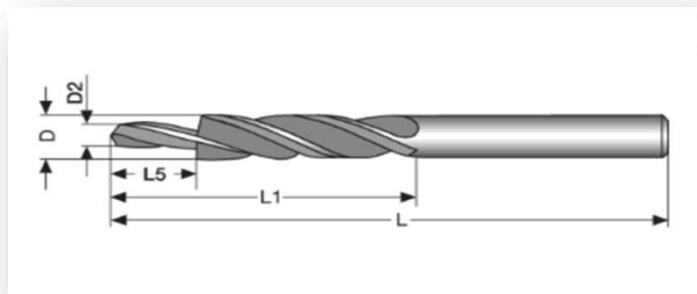
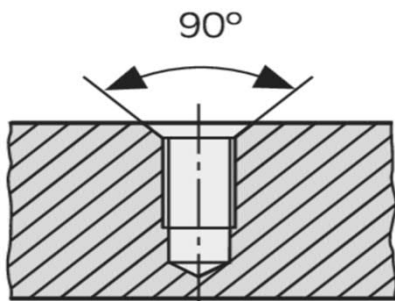

VHM STUFENBOHRER							PREIS
ARTIKEL NR.	D	D2	D1	L5	L1	L	
AD1810-M3	6	2,5	6	8,8	28	66	
AD1810-M4	6	3,3	6	11,4	28	66	
AD1810-M5	6	5	6	13,6	28	66	
AD1810-M6	8	6,8	8	16,5	41	79	
AD1810-M8	10	8,5	10	21	47	89	
AD1810-M10	12	10,2	12	25,5	55	102	
AD1810-M12	14	11,2	14	30	60	107	

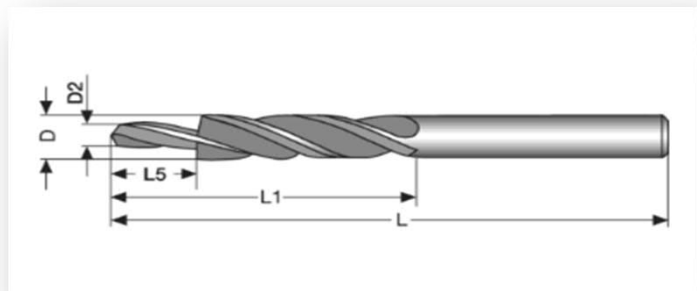
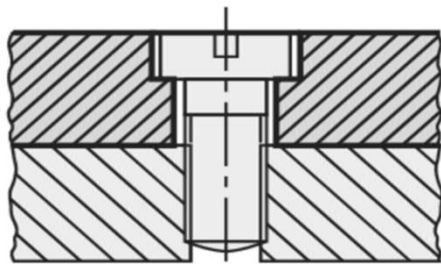

VHM STUFENBOHRER							PREIS
ARTIKEL NR.	D	D2	D1	L5	L1	L	
AD1820-M3	6	3,4	6	9	28	64	
AD1820-M4	8	4,5	8	11	37	79	
AD1820-M5	10	5,5	10	13	43	89	
AD1820-M6	11	6,6	11	15	55	102	
AD1820-M8	15	9	15	19	60	115	
AD1820-M10	18	11	18	23	62	123	

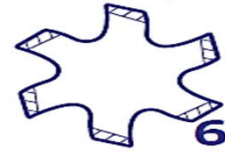
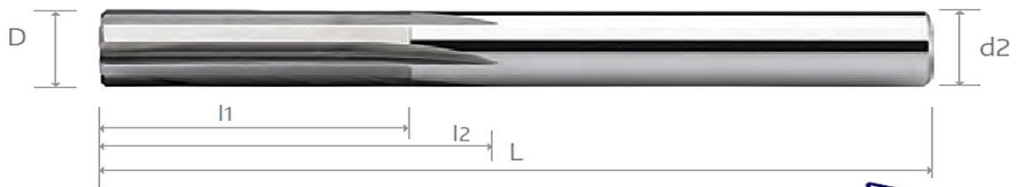

VHM H7 REIBAHLE GERADE						PREIS
ARTIKEL NR.	D (H7)	l1	l2	L	d2 (h6)	
AD207-05.005	5	23	40	75	6	
AD207-05.010	5	23	45	80	6	
AD207-06.005	6	26	40	75	8	
AD207-06.010	6	26	60	100	8	
AD207-08.005	8	26	40	80	10	
AD207-08.015	8	33	70	110	10	
AD207-10.005	10	32	42	82	12	
AD207-10.010	10	38	75	120	12	
AD207-12.005	12	35	47	92	14	
AD207-12.010	12	44	100	150	14	
AD207-14.005	14	38	52	100	16	
AD207-14.010	14	47	110	165	16	
AD207-16.005	16	45	55	100	18	
AD207-16.010	16	52	110	165	18	

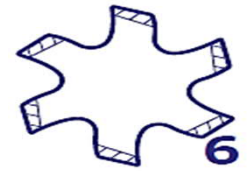
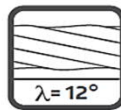

VHM H7 REIBAHLE MIT DRALL						PREIS
ARTIKEL NR.	D (H7)	l1	l2	L	d2 (h6)	
AD217-05.005	5	23	40	75	6	
AD217-05.010	5	23	45	80	6	
AD217-06.005	6	26	40	75	8	
AD217-06.010	6	26	60	100	8	
AD217-08.005	8	26	40	80	10	
AD217-08.010	8	33	70	110	10	
AD217-10.005	10	32	42	83	12	
AD217-10.010	10	38	75	120	12	
AD217-12.005	12	35	47	92	14	
AD217-12.010	12	44	100	150	14	
AD217-14.005	14	38	52	100	16	
AD217-14.010	14	47	110	165	16	
AD217-16.005	16	45	55	100	18	
AD217-16.010	16	52	110	165	18	

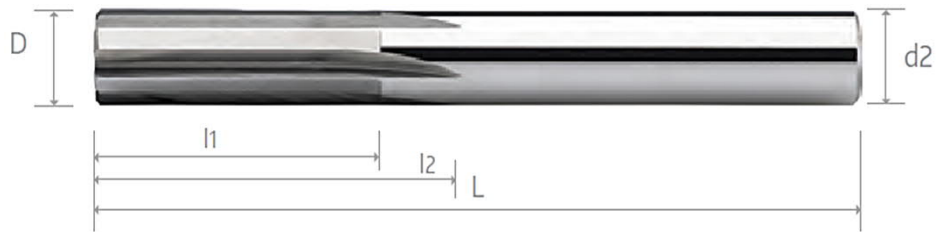

VHM H5 REIBAHLE GERADE							PREIS
ARTIKEL NR.	D (H7)	l1	l2	L	d2 (h6)	Sütun1	
AD205-05.005	5	26	40	75	6		
AD205-05.010	5	23	45	80	6		
AD205-06.005	6	26	40	75	6		
AD205-06.010	6	26	60	100	6		
AD205-08.005	8	26	40	80	8		
AD205-08.015	8	33	70	110	8		
AD205-10.005	10	32	42	82	10		
AD205-10.010	10	38	75	120	10		
AD205-12.005	12	35	47	100	12		
AD205-12.010	12	44	100	150	12		
AD205-14.005	14	38	52	100	14		
AD205-14.010	14	47	110	165	14		
AD205-16.005	16	45	55	100	16		
AD205-16.010	16	52	110	165	16		

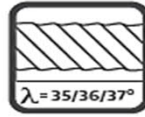
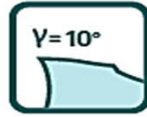
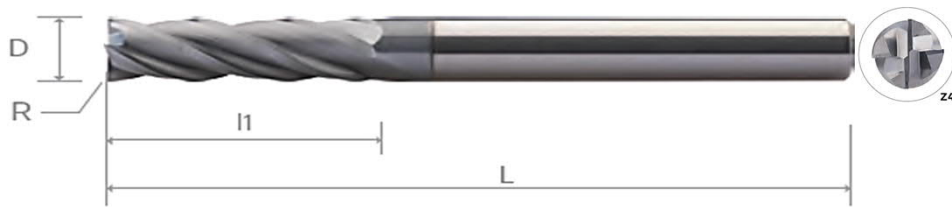

VHM SCHAFTFRÄSER 35-37°						PREIS
ARTIKEL NR.	D (h10)	l1	L	d2 (h6)2	R	Sütun1
AD500-06.005	6	13	57	6	0.1	
AD500-06.010	6	25	75	6	0.1	
AD500-08.005	8	16	63	8	0.2	
AD500-08.010	8	30	75	8	0.2	
AD500-10.005	10	22	72	10	0.2	
AD500-10.010	10	40	100	10	0.2	
AD500-12.005	12	26	83	12	0.3	
AD500-12.010	12	45	100	12	0.3	
AD500-14.005	14	30	82	14	0.3	
AD500-16.005	16	32	92	16	0.3	
AD500-16.010	16	65	120	16	0.3	
AD500-20.005	20	38	104	20	0.3	
AD500-20.010	20	65	120	20	0.3	



VHM SCHAFTFRÄSER 30°							PREIS
ARTIKEL NR	D (h10)	l1	L	d2 (h6)	Z	Sütun1	
AD540-06.005	6	16	50	6	4		
AD540-06.010	6	20	60	6	4		
AD540-06.015	6	38	100	6	4		
AD540-08.005	8	20	63	8	4		
AD540-08.010	8	31	75	8	4		
AD540-08.015	8	41	100	8	4		
AD540-10.005	10	22	75	10	4		
AD540-10.010	10	31	75	10	4		
AD540-10.015	10	50	100	10	4		
AD540-10.020	10	57	133	10	4		
AD540-12.005	12	25	75	12	4		
AD540-12.010	12	50	100	12	4		
AD540-12.015	12	75	150	12	4		
AD540-14.005	14	32	92	14	4		
AD540-14.010	14	57	120	14	4		
AD540-14.015	14	75	150	14	4		
AD540-16.005	16	32	92	16	4		
AD540-16.010	16	57	120	16	4		
AD540-16.015	16	75	150	16	4		
AD540-16.020	16	100	165	16	4		
AD540-18.005	18	38	100	18	4		
AD540-18.010	18	57	130	18	4		
AD540-18.015	18	75	150	18	4		
AD540-20.005	20	38	100	20	4		
AD540-20.010	20	57	120	20	4		
AD540-20.015	20	75	150	20	4		
AD540-20.020	20	100	165	20	4		
AD540-25.005	25	50	100	25	4		
AD540-25.010	25	75	150	25	4		
AD540-25.015	25	100	175	25	4		
AD540-25.020	25	150	200	25	4		
AD540-32.005	32	50	100	32	4		
AD540-32.010	32	75	150	32	4		
AD540-32.015	32	100	175	32	4		
AD540-32.020	32	150	200	32	4		

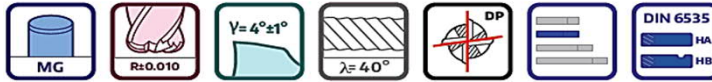
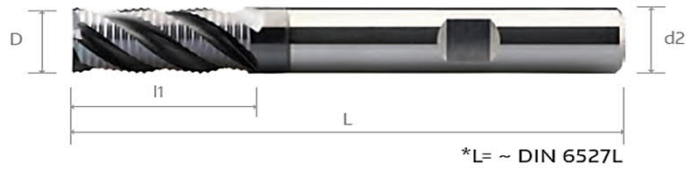

VHM SCHRUPPFRÄSER							PREIS
ARTIKEL NR	D (h10)	l1	L	d2 (h6)	Z	Sütun1	
AD570-06.005	6	13	57	6	4		
AD570-06.010	6	20	57	6	4		
AD570-08.005	8	20	63	8	4		
AD570-08.010	8	30	63	8	4		
AD570-10.005	10	22	72	10	4		
AD570-10.010	10	32	72	10	4		
AD570-12.005	12	26	83	12	4		
AD570-12.010	12	37	83	12	4		
AD570-14.005	14	26	82	14	4		
AD570-14.010	14	44	82	14	4		
AD570-16.005	16	32	92	16	4		
AD570-16.010	16	46	92	16	4		
AD570-18.005	18	32	92	18	4		
AD570-18.010	18	53	92	18	4		
AD570-20.005	20	38	104	20	4		
AD570-20.010	20	58	104	20	4		

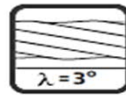
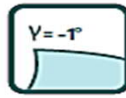
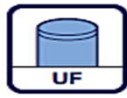

Z4/6

VHM HIGH FEED							PREIS
ARTIKEL NR.	D (h10)	l1	l2	L	d2 (h6)	R - Z	
AD520-03.005	3	1.5	6	55	6	0.3-4	
AD520-03.010	3	1.5	12	55	6	0.3-4	
AD520-04.005	4	1.5	8	55	6	0.4-4	
AD520-04.010	4	1.5	16	55	6	0.4-4	
AD520-05.005	5	2	10	55	6	0.5-4	
AD520-05.010	5	2	22	55	6	0.5-4	
AD520-06.005	6	2.5	12	55	6	0.6-4	
AD520-06.010	6	2.5	26	55	6	0.6-4	
AD520-08.005	8	3	16	65	8	0.8-6	
AD520-08.010	8	3	32	65	8	0.8-6	
AD520-10.005	10	3.5	20	82	10	1-6	
AD520-10.010	10	3.5	36	82	10	1-6	
AD520-12.005	12	4	24	82	12	1.2-6	
AD520-12.010	12	4	43	82	12	1.2-6	

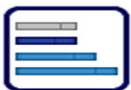
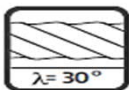
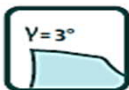

VHM KUGELFRÄSER							PREIS
ARTIKEL NR	D (h10)	R	l1	L	d2 (h6)	Z	
AD560-03.005	3	1.5	10	50	6	2	
AD560-03.010	3	1.5	10	75	6	2	
AD560-03.015	3	1.5	10	100	6	2	
AD560-04.010	4	2	12	50	6	2	
AD560-04.015	4	2	12	75	6	2	
AD560-04.020	4	2	12	100	6	2	
AD560-05.005	5	2.5	13	50	6	2	
AD560-05.010	5	2.5	13	75	6	2	
AD560-05.015	5	2.5	13	100	6	2	
AD560-06.005	6	3	14	66	6	2	
AD560-06.010	6	3	14	75	6	2	
AD560-06.015	6	3	14	100	6	2	
AD560-06.020	6	3	14	150	6	2	
AD560-08.005	8	4	16	63	8	2	
AD560-08.010	8	4	16	75	8	2	
AD560-08.015	8	4	16	100	8	2	
AD560-08.020	8	4	16	150	8	2	
AD560-10.005	10	5	18	70	10	2	
AD560-10.010	10	5	18	100	10	2	
AD560-10.015	10	5	18	123	10	2	
AD560-10.020	10	5	18	150	10	2	
AD560-12.005	12	6	20	75	12	2	
AD560-12.010	12	6	20	100	12	2	
AD560-12.015	12	6	20	123	12	2	
AD560-12.020	12	6	20	150	12	2	
AD560-14.005	14	7	24	92	14	2	
AD560-14.010	14	7	24	120	14	2	
AD560-14.015	14	7	24	150	14	2	
AD560-14.020	14	7	24	200	14	2	
AD560-16.005	16	8	24	92	16	2	
AD560-16.010	16	8	24	120	16	2	
AD560-16.015	16	8	24	150	16	2	
AD560-16.020	16	8	24	200	16	2	
AD560-20.005	20	10	30	110	20	2	
AD560-20.010	20	10	30	165	20	2	
AD560-20.015	20	10	30	200	20	2	
AD560-25.005	25	12.5	40	110	25	2	
AD560-25.010	25	12.5	40	165	25	2	
AD560-25.015	25	12.5	40	200	25	2	
AD560-32.005	32	16	50	130	32	2	
AD560-32.010	32	16	50	165	32	2	
AD560-32.015	32	16	50	200	32	2	



VHM MULTIFRÄSER Z6						PREIS
ARTIKEL NR	D (h10)	l1	L	d2 (h6)	Z	Sütun1
AD576-06.005	6	15	50	6	6	
AD576-06.010	6	20	60	6	6	
AD576-06.015	6	31	75	6	6	
AD576-06.020	6	38	100	6	6	
AD576-08.005	8	20	60	8	6	
AD576-08.010	8	31	75	8	6	
AD576-08.015	8	41	100	8	6	
AD576-10.005	10	22	70	10	6	
AD576-10.010	10	45	100	10	6	
AD576-10.015	10	57	110	10	6	
AD576-12.005	12	25	75	12	6	
AD576-12.010	12	50	100	12	6	
AD576-12.015	12	75	150	12	6	
AD576-14.005	14	30	92	14	6	
AD576-14.010	14	57	120	14	6	
AD576-14.015	14	75	150	14	6	



VHM MULTIFRÄSER Z8						PREIS
ARTIKEL NR	D (h10)	l1	L	d2 (h6)	Z	Sütun1
AD578-16.005	16	30	90	16	8	
AD578-16.010	16	57	120	16	8	
AD578-16.015	16	75	150	16	8	
AD578-16.020	16	100	165	16	8	
AD578-18.005	18	35	100	18	8	
AD578-18.010	18	57	130	18	8	
AD578-18.015	18	75	150	18	8	
AD578-18.020	18	100	165	18	8	
AD578-20.005	20	38	100	20	8	
AD578-20.010	20	57	120	20	8	
AD578-20.015	20	75	150	20	8	
AD578-20.020	20	100	165	20	8	
AD578-20.025	20	150	200	20	8	

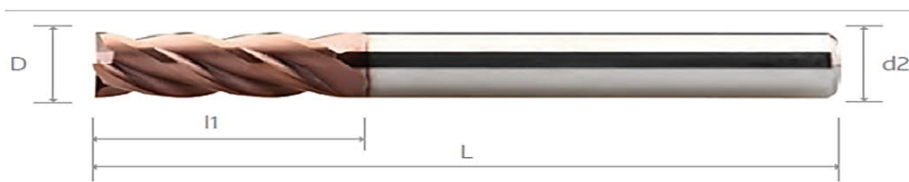

VHM SCHAFTFRÄSER 65 HRC							PREIS
ARTIKEL NR	D (h10)	l1	L	d2 (h6)	Z	Sütun1	
AD5408-06.005	6	16	50	6	4		
AD5408-06.010	6	20	60	6	4		
AD5408-06.015	6	38	100	6	4		
AD5408-08.005	8	20	65	8	4		
AD5408-08.010	8	31	75	8	4		
AD5408-08.020	8	41	100	8	4		
AD5408-10.005	10	22	75	10	4		
AD5408-10.010	10	31	75	10	4		
AD5408-10.015	10	50	100	10	4		
AD5408-10.020	10	57	123	10	4		
AD5408-12.005	12	25	75	12	4		
AD5408-12.010	12	50	100	12	4		
AD5408-12.015	12	75	150	12	4		
AD5408-14.005	14	32	90	14	4		
AD5408-14.015	14	57	120	14	4		
AD5408-14.020	14	75	150	14	4		
AD5408-16.005	16	32	90	16	4		
AD5408-16.010	16	57	120	16	4		
AD5408-16.015	16	75	150	16	4		
AD5408-16.020	16	100	165	16	4		
AD5408-20.005	20	38	90	20	4		
AD5408-20.010	20	57	120	20	4		
AD5408-20.015	20	75	150	20	4		
AD5408-20.020	20	100	165	20	4		

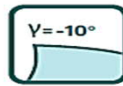
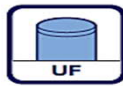

VHM KUGELFRÄSER 65 HRC							PREIS
ARTIKEL NR	D (h10)	R	l1	L	d2 (h6)	Z	
AD5608-03.005	3	1.5	10	55	6	2	
AD5608-03.010	3	1.5	10	75	6	2	
AD5608-03.015	3	1.5	10	100	6	2	
AD5608-04.010	4	2	12	55	6	2	
AD5608-04.015	4	2	12	75	6	2	
AD5608-04.020	4	2	12	100	6	2	
AD5608-05.005	5	2.5	13	55	6	2	
AD5608-05.010	5	2.5	13	75	6	2	
AD5608-05.015	5	2.5	13	100	6	2	
AD5608-06.005	6	3	14	65	6	2	
AD5608-06.010	6	3	14	75	6	2	
AD5608-06.015	6	3	14	100	6	2	
AD5608-06.020	6	3	14	150	6	2	
AD5608-08.005	8	4	16	65	8	2	
AD5608-08.010	8	4	16	75	8	2	
AD5608-08.015	8	4	16	100	8	2	
AD5608-08.020	8	4	16	150	8	2	
AD5608-10.005	10	5	18	70	10	2	
AD5608-10.010	10	5	18	100	10	2	
AD5608-10.015	10	5	18	123	10	2	
AD5608-10.020	10	5	18	150	10	2	
AD5608-12.005	12	6	20	75	12	2	
AD5608-12.010	12	6	20	100	12	2	
AD5608-12.015	12	6	20	123	12	2	
AD5608-12.020	12	6	20	150	12	2	
AD5608-14.005	14	7	24	90	14	2	
AD5608-14.010	14	7	24	120	14	2	
AD5608-14.015	14	7	24	150	14	2	
AD5608-14.020	14	7	24	200	14	2	
AD5608-16.005	16	8	24	90	16	2	
AD5608-16.010	16	8	24	120	16	2	
AD5608-16.015	16	8	24	150	16	2	
AD5608-16.020	16	8	24	200	16	2	
AD5608-20.005	20	10	30	110	20	2	
AD5608-20.010	20	10	30	165	20	2	
AD5608-20.015	20	10	30	200	20	2	
AD5608-25.005	25	12.5	40	110	25	2	
AD5608-25.010	25	12.5	40	165	25	2	
AD5608-25.015	25	12.5	40	200	25	2	
AD5608-32.005	32	16	50	110	32	2	
AD5608-32.010	32	16	50	165	32	2	
AD5608-32.015	32	16	50	200	32	2	



VHM MULTIFRÄSER 65 HRC Z6							PREIS
ARTIKEL NR	D (h10)	l1	L	d2 (h6)	Z	Sütun1	Sütun1
AD5768-06.005	6	15	50	6	6		
AD5768-06.010	6	20	60	6	6		
AD5768-06.015	6	31	82	6	6		
AD5768-06.020	6	38	100	6	6		
AD5768-08.005	8	20	60	8	6		
AD5768-08.010	8	31	75	8	6		
AD5768-08.015	8	41	100	8	6		
AD5768-10.005	10	22	70	10	6		
AD5768-10.010	10	45	100	10	6		
AD5768-10.015	10	57	123	10	6		
AD5768-12.005	12	25	75	12	6		
AD5768-12.010	12	50	100	12	6		
AD5768-12.015	12	75	150	12	6		
AD5768-14.005	14	30	82	14	6		
AD5768-14.010	14	57	123	14	6		
AD5768-14.015	14	75	150	14	6		



VHM MULTIFRÄSER 65 HRC Z8							PREIS
ARTIKEL NR	D (h10)	l1	L	d2 (h6)	Z		
AD5788-16.005	16	30	90	16	8		
AD5788-16.010	16	57	120	16	8		
AD5788-16.015	16	75	150	16	8		
AD5788-16.020	16	100	165	16	8		
AD5788-18.005	18	35	100	18	8		
AD5788-18.010	18	57	130	18	8		
AD5788-18.015	18	75	150	18	8		
AD5788-18.020	18	100	165	18	8		
AD5788-20.005	20	38	100	20	8		
AD5788-20.010	20	57	120	20	8		
AD5788-20.015	20	75	150	20	8		
AD5788-20.020	20	100	165	20	8		
AD5788-20.025	20	150	200	20	8		



VHM RADIUSFRÄSER 65 HRC							PREIS
ARTIKEL NR	D (h10)	l1	L	d2	R	Sütun1	
AD5858-03.005	3	9	50	6	0.2		
AD5858-03.010	3	9	50	6	0.3		
AD5858-03.015	3	9	50	6	0.5		
AD5858-03.020	3	19	75	6	0.2		
AD5858-03.025	3	19	75	6	0.3		
AD5858-03.030	3	19	75	6	0.5		
AD5858-03.035	3	25	100	6	0.2		
AD5858-03.040	3	25	100	6	0.3		
AD5858-03.045	3	25	100	6	0.5		
AD5858-04.005	4	12	50	6	0.2		
AD5858-04.010	4	12	50	6	0.3		
AD5858-04.015	4	12	50	6	0.5		
AD5858-04.020	4	12	50	6	1		
AD5858-04.025	4	19	75	6	0.2		
AD5858-04.030	4	19	75	6	0.3		
AD5858-04.035	4	19	75	6	0.5		
AD5858-04.040	4	19	75	6	1		
AD5858-04.045	4	31	100	6	0.2		
AD5858-04.050	4	31	100	6	0.3		
AD5858-04.055	4	31	100	6	0.5		
AD5858-04.060	4	31	100	6	1		
AD5858-05.005	5	12	50	6	0.2		
AD5858-05.010	5	12	50	6	0.3		
AD5858-05.015	5	12	50	6	0.5		
AD5858-05.020	5	12	50	6	1		
AD5858-05.025	5	19	75	6	0.2		
AD5858-05.030	5	19	75	6	0.3		
AD5858-05.035	5	19	75	6	0.5		
AD5858-05.040	5	19	75	6	1		
AD5858-05.045	5	31	100	6	0.2		
AD5858-05.050	5	31	100	6	0.3		
AD5858-05.055	5	31	100	6	0.5		
AD5858-05.060	5	31	100	6	1		
AD5858-06.005	6	15	50	6	0.2		
AD5858-06.010	6	15	50	6	0.3		
AD5858-06.015	6	15	50	6	0.5		
AD5858-06.020	6	15	50	6	1		
AD5858-06.025	6	20	60	6	0.2		
AD5858-06.030	6	20	60	6	0.3		

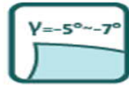

VHM RADIUSFRÄSER 65 HRC						PREIS
ARTIKEL NR	D (h10)	l1	L	d2	R	
AD5858-06.035	6	20	60	6	0.5	
AD5858-06.040	6	20	60	6	1	
AD5858-06.045	6	31	75	6	0.2	
AD5858-06.050	6	31	75	6	0.3	
AD5858-06.055	6	31	75	6	0.5	
AD5858-06.060	6	31	75	6	1	
AD5858-06.065	6	38	100	6	0.2	
AD5858-06.070	6	38	100	6	0.3	
AD5858-06.075	6	38	100	6	0.5	
AD5858-06.080	6	38	100	6	1	
AD5858-08.005	8	20	60	8	0.2	
AD5858-08.010	8	20	60	8	0.3	
AD5858-08.015	8	20	60	8	0.5	
AD5858-08.020	8	20	60	8	1	
AD5858-08.025	8	20	60	8	1.5	
AD5858-08.030	8	20	60	8	2	
AD5858-08.035	8	31	75	8	0.2	
AD5858-08.040	8	31	75	8	0.3	
AD5858-08.045	8	31	75	8	0.5	
AD5858-08.050	8	31	75	8	1	
AD5858-08.055	8	31	75	8	1.5	
AD5858-08.060	8	31	75	8	2	
AD5858-08.065	8	41	100	8	0.2	
AD5858-08.070	8	41	100	8	0.3	
AD5858-08.075	8	41	100	8	0.5	
AD5858-08.080	8	41	100	8	1	
AD5858-08.085	8	41	100	8	1.5	
AD5858-08.090	8	41	100	8	2	
AD5858-10.005	10	22	70	10	0.2	
AD5858-10.010	10	22	70	10	0.3	
AD5858-10.015	10	22	70	10	0.5	
AD5858-10.020	10	22	70	10	1	
AD5858-10.025	10	22	70	10	1.5	
AD5858-10.030	10	22	70	10	2	
AD5858-10.035	10	45	100	10	0.2	
AD5858-10.040	10	45	100	10	0.3	
AD5858-10.045	10	45	100	10	0.5	
AD5858-10.050	10	45	100	10	1	
AD5858-10.055	10	45	100	10	1.5	

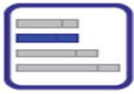
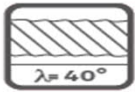
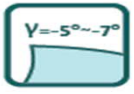

VHM RADIUSFRÄSER 65 HRC

PREIS

ARTIKEL NR	D (h10)	l1	L	d2	R	Sütun1	
AD5858-10.060	10	45	100	10	2		
AD5858-10.065	10	57	120	10	0.2		
AD5858-10.070	10	57	120	10	0.3		
AD5858-10.075	10	57	120	10	0.5		
AD5858-10.080	10	57	120	10	1		
AD5858-10.085	10	57	120	10	1.5		
AD5858-10.090	10	57	120	10	2		
AD5858-12.005	12	25	75	12	0.2		
AD5858-12.010	12	25	75	12	0.3		
AD5858-12.015	12	25	75	12	0.5		
AD5858-12.020	12	25	75	12	1		
AD5858-12.025	12	25	75	12	1.5		
AD5858-12.030	12	25	75	12	2		
AD5858-12.035	12	25	75	12	3		
AD5858-12.040	12	50	100	12	0.2		
AD5858-12.045	12	50	100	12	0.3		
AD5858-12.050	12	50	100	12	0.5		
AD5858-12.055	12	50	100	12	1		
AD5858-12.060	12	50	100	12	1.5		
AD5858-12.065	12	50	100	12	2		
AD5858-12.070	12	50	100	12	3		
AD5858-12.075	12	75	150	12	0.2		
AD5858-12.080	12	75	150	12	0.3		
AD5858-12.085	12	75	150	12	0.5		
AD5858-12.090	12	75	150	12	1		
AD5858-12.095	12	75	150	12	1.5		
AD5858-12.100	12	75	150	12	2		
AD5858-12.105	12	75	150	12	3		
AD5858-14.005	14	30	90	14	0.3		
AD5858-14.010	14	30	90	14	0.5		
AD5858-14.015	14	30	90	14	1		
AD5858-14.020	14	30	90	14	1.5		
AD5858-14.025	14	30	90	14	2		
AD5858-14.030	14	30	90	14	3		
AD5858-14.035	14	57	120	14	0.3		
AD5858-14.040	14	57	120	14	0.5		
AD5858-14.045	14	57	120	14	1		
AD5858-14.050	14	57	120	14	1.5		
AD5858-14.055	14	57	120	14	2		



VHM RADIUSFRÄSER 65 HRC						PREIS
ARTIKEL NR	D (h10)	l1	L	d2	R	
AD5858-14.060	14	57	120	14	3	
AD5858-14.065	14	75	150	14	0.3	
AD5858-14.070	14	75	150	14	0.5	
AD5858-14.075	14	75	150	14	1	
AD5858-14.080	14	75	150	14	1.5	
AD5858-14.085	14	75	150	14	2	
AD5858-14.090	14	75	150	14	3	
AD5858-16.005	16	30	90	16	0.3	
AD5858-16.010	16	30	90	16	0.5	
AD5858-16.015	16	30	90	16	1	
AD5858-16.020	16	30	90	16	1.5	
AD5858-16.025	16	30	90	16	2	
AD5858-16.030	16	30	90	16	3	
AD5858-16.035	16	57	120	16	0.3	
AD5858-16.040	16	57	120	16	0.5	
AD5858-16.045	16	57	120	16	1	
AD5858-16.050	16	57	120	16	1.5	
AD5858-16.055	16	57	120	16	2	
AD5858-16.060	16	57	120	16	3	
AD5858-16.065	16	75	150	16	0.3	
AD5858-16.070	16	75	150	16	0.5	
AD5858-16.075	16	75	150	16	1	
AD5858-16.080	16	75	150	16	1.5	
AD5858-16.085	16	75	150	16	2	
AD5858-16.090	16	75	150	16	3	
AD5858-18.005	18	35	90	18	0.3	
AD5858-18.010	18	35	90	18	0.5	
AD5858-18.015	18	35	90	18	1	
AD5858-18.020	18	35	90	18	1.5	
AD5858-18.025	18	35	90	18	2	
AD5858-18.030	18	35	90	18	3	
AD5858-18.035	18	57	120	18	0.3	
AD5858-18.040	18	57	120	18	0.5	
AD5858-18.045	18	57	120	18	1	
AD5858-18.050	18	57	120	18	1.5	
AD5858-18.055	18	57	120	18	2	
AD5858-18.060	18	57	120	18	3	
AD5858-18.065	18	75	150	18	0.3	
AD5858-18.070	18	75	150	18	0.5	

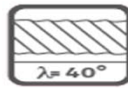
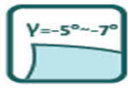

VHM RADIUSFRÄSER 65 HRC							PREIS
ARTIKEL NR	D (h10)	l1	L	d2	R		
AD5858-18.075	18	75	150	18	1		
AD5858-18.080	18	75	150	18	1.5		
AD5858-18.085	18	75	150	18	2		
AD5858-18.090	18	75	150	18	3		
AD5858-20.005	20	38	90	20	0.3		
AD5858-20.010	20	38	90	20	0.5		
AD5858-20.015	20	38	90	20	1		
AD5858-20.020	20	38	90	20	1.5		
AD5858-20.025	20	38	90	20	2		
AD5858-20.030	20	38	90	20	3		
AD5858-20.035	20	57	120	20	0.3		
AD5858-20.040	20	57	120	20	0.5		
AD5858-20.045	20	57	120	20	1		
AD5858-20.050	20	57	120	20	1.5		
AD5858-20.055	20	57	120	20	2		
AD5858-20.060	20	57	120	20	3		
AD5858-20.065	20	75	150	20	0.3		
AD5858-20.070	20	75	150	20	0.5		
AD5858-20.075	20	75	150	20	1		
AD5858-20.080	20	75	150	20	1.5		
AD5858-20.085	20	75	150	20	2		
AD5858-20.090	20	75	150	20	3		



VHM ALUFRÄSER Z1							PREIS
ARTIKEL NR	D (h10)	l1	L	d2 (h6)	Z	Sütun1	
AD7001-03.005	3	12	50	6	1		
AD7001-04.005	4	15	50	6	1		
AD7001-05.005	5	16	50	6	1		
AD7001-06.005	6	20	60	6	1		
AD7001-08.005	8	22	63	8	1		
AD7001-10.005	10	25	72	10	1		
AD7001-12.005	12	30	83	12	1		



VHM ALUFRÄSER Z2							PREIS
ARTIKEL NR	D (h10)	l1	L	d2 (h6)	Z		
AD7002-06.005	6	9	60	6	2		
AD7002-06.010	6	20	60	6	2		
AD7002-08.005	8	12	63	8	2		
AD7002-08.010	8	20	63	8	2		
AD7002-10.005	10	15	75	10	2		
AD7002-10.010	10	22	75	10	2		
AD7002-12.005	12	18	75	12	2		
AD7002-12.010	12	25	75	12	2		
AD7002-14.005	14	24	92	14	2		
AD7002-14.010	14	32	92	14	2		
AD7002-16.005	16	24	92	16	2		
AD7002-16.010	16	32	92	16	2		
AD7002-18.005	18	32	92	18	2		
AD7002-18.010	18	38	100	18	2		
AD7002-20.005	20	38	100	20	2		
AD7002-20.010	20	50	100	20	2		

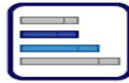
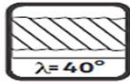

VHM ALUFRÄSER Z3						PREIS
ARTIKEL NR	D (h10)	l1	L	d2 (h6)	Z	
AD7003-06.005	6	9	60	6	3	
AD7003-06.010	6	20	60	6	3	
AD7003-08.005	8	12	63	8	3	
AD7003-08.010	8	20	63	8	3	
AD7003-10.005	10	15	75	10	3	
AD7003-10.010	10	22	75	10	3	
AD7003-12.005	12	18	75	12	3	
AD7003-12.010	12	25	75	12	3	
AD7003-14.005	14	24	92	14	3	
AD7003-14.010	14	32	92	14	3	
AD7003-16.005	16	24	92	16	3	
AD7003-16.010	16	32	92	16	3	
AD7003-18.005	18	32	92	18	3	
AD7003-18.010	18	38	100	18	3	
AD7003-20.005	20	38	100	20	3	
AD7003-20.010	20	50	100	20	3	

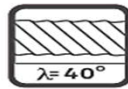

VHM ALU-SCHRUPPFRÄSER Z3							PREIS
ARTIKEL NR	D (h10)	l1	L	d2 (h6)	Z	Sütun1	
AD7005-06.005	6	13	57	6	3		
AD7005-06.010	6	20	57	6	3		
AD7005-08.005	8	20	63	8	3		
AD7005-08.010	8	30	63	8	3		
AD7005-10.005	10	22	72	10	3		
AD7005-10.010	10	32	72	10	3		
AD7005-12.005	12	26	83	12	3		
AD7005-12.010	12	37	83	12	3		
AD7005-14.005	14	26	82	14	3		
AD7005-14.010	14	44	82	14	3		
AD7005-16.005	16	32	92	16	3		
AD7005-16.010	16	46	92	16	3		
AD7005-18.005	18	32	92	18	3		
AD7005-18.010	18	46	92	18	3		
AD7005-20.005	20	38	104	20	3		
AD7005-20.010	20	58	104	20	3		

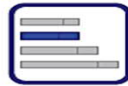
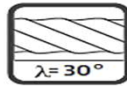

VHM ALU-KUGELFRÄSER							PREIS
ARTIKEL NR	D (h10)	R	l1	L	d2 (h6)	Z	
AD7010-03.005	3	1.5	10	65	6	2	
AD7010-04.005	4	2	12	65	6	2	
AD7010-05.005	5	2.5	13	65	6	2	
AD7010-06.005	6	3	14	65	6	2	
AD7010-08.005	8	4	16	65	8	2	
AD7010-10.005	10	5	18	70	10	2	
AD7010-12.005	12	6	20	75	12	2	
AD7010-14.005	14	7	24	92	14	2	
AD7010-16.005	16	8	24	92	16	2	
AD7010-18.005	18	9	26	104	18	2	
AD7010-20.005	20	10	30	110	20	2	



SENKFRÄSER							PREIS
ARTIKEL NR	D (h10)	R	l1	L	Sütun2	Sütun1	
AD610-06.005	6	16	6	50			
AD610-06.010	6	16	6	75			
AD610-06.015	6	16	6	100			
AD610-08.005	8	20	8	63			
AD610-08.010	8	20	8	100			
AD610-10.005	10	25	10	75			
AD610-10.010	10	25	10	100			
AD610-10.015	10	25	10	133			
AD610-12.005	12	25	12	75			
AD610-12.010	12	25	12	100			
AD610-12.015	12	25	12	150			
AD610-16.005	16	26	16	92			
AD610-16.010	16	26	16	120			
AD610-16.015	16	26	16	150			

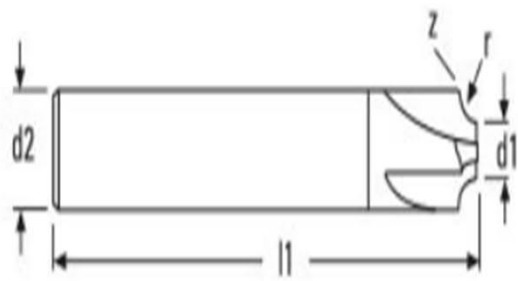

RADIUSFRÄSER						PREIS
ARTIKEL NR	d1	d2 (h6)	l1	r	z	
AD615-08.005	7	8	63	0.5	4	
AD615-08.010	6	8	63	1	4	
AD615-10.005	7	10	80	1.5	4	
AD615-10.010	6	10	80	2	4	
AD615-12.005	7	12	82	2.5	4	
AD615-12.010	6	12	82	3	4	
AD615-16.005	7	16	92	3.5	4	
AD615-16.010	6	16	92	4	4	
AD615-16.015	7	16	92	4.5	4	
AD615-20.005	6	20	92	5	4	
AD615-20.010	8	20	104	6	4	

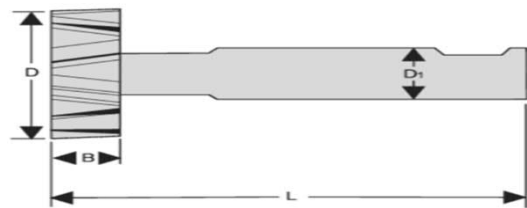

SCHLITZFRÄSER						PREIS
ARTIKEL NR	D h10	B	L	D1 H6	z	
AD630-10	10,5	2	50	6	6	
AD630-15	10,5	3	50	6	6	
AD630-20	13,5	2	56	10	8	
AD630-25	13,5	3	56	10	8	
AD630-30	13,5	4	56	10	8	
AD630-35	16,5	3	56	10	10	
AD630-40	16,5	4	56	10	10	
AD630-45	19,5	3	63	10	10	
AD630-50	19,5	4	63	10	10	
AD630-55	22,5	4	63	10	10	
AD630-60	22,5	5	63	10	10	
AD630-65	28,5	5	63	10	10	
AD630-70	32,5	5	71	12	10	
AD630-75	38,5	10	71	12	10	
AD630-80	45,5	10	71	12	10	